

LIEBHERR



Technical Sales manual Laboratory appliances

Quality, design and innovation



Find it at eu.fishersci.com

 **fisher scientific**
part of Thermo Fisher Scientific

Contents

Laboratory fridges and freezers from Liebherr	03
Why a laboratory appliance and not a domestic appliance?	03
Applications for laboratory and pharmacy fridges and freezers	04
Typology	04
General laboratory use	05
Why should a spark-free appliance be used?	05
Storage of medicines/pharmaceuticals requiring refrigeration	06
Alarm, memory and security functions	07
Temperature, door open and power failure alarm	07
Alarm notifications for controller malfunctions/faults	08
Internal memory functions	08
Special safety function	08
Temperature and alarm documentation	09
Connection for external temperature and alarm monitoring	09
Connection contact for external alarm system	10
Connection for product temperature monitoring	11
Pharmacy fridges compliant with DIN 58345	12
Overview of safety features	13
Controllers and functions	18
Operating and control elements of electronic controller	18
Functional overview of controls	19
Cleaning and disinfection instructions	21
Heat emission	22
Cable length	22
Quality test certificate	22
Appliance temperature performance to IEC 60068	23
Description of the test procedure according to EN 60068	23
Test results according to EN 60068-3 for laboratory appliances LKPv and LGPv	26
Test results according to EN 60068-3 for laboratory appliances LK(U)v, LC(ex)v, LK(U)exv, LG(U)ex and LGT	30
Test results according to EN 60068-3 for pharmacy fridges according to DIN 58345	39
Test results according to EN 60068-3 for laboratory appliances LKexv	43
Ultra-low temperature freezers: Maximum Rack-Loading SUFsg 5001/7001	45
Loading sketches: Laboratory chest freezers with cryo racks	46

Laboratory fridges and freezers from Liebherr

Fridges and freezers for use in the laboratory and in research have to meet particularly high requirements, especially in terms of safety and temperature consistency. Liebherr appliances therefore have numerous functions and features for the best possible storage of sensitive samples, sensitive chemicals and research materials. The precise controls enable accurate temperature adjustment – and, in conjunction with the highly effective insulation and dynamic cooling system, create optimum storage conditions. Integrated visual and audio alarms warn in case of unwanted temperature deviations. Liebherr fridges and freezers offer you the safety that is essential in the laboratory and research sector – 24 hours a day, 365 days a year.

Why a laboratory appliance and not a domestic appliance?

Applications

The use of special laboratory fridges/freezers can have various reasons, which may also vary nationally due to regulations. In principle, laboratory appliances are preferable to domestic appliances and simple commercial appliances due to the following features:

Temperature stability and safe storage

When storing sensitive substances, preparations, etc., strict limits for storage temperatures are required. These are maintained with Liebherr laboratory appliances which are designed to provide controlled temperatures at all positions inside the appliance. However, domestic appliances are intended for the non-critical storage of food products, sometimes have no or only weak internal forced-air systems and just cannot guarantee the same level of temperature stability. The temperature displays usually react very slowly or even only show the set value not the real internal temperature. The refrigeration systems are not designed to operate within tight temperature bands, even less so under intensive use. If the temperature of a laboratory appliance exceeds its alarm settings an alarm can be triggered immediately, unlike domestic or basic commercial fridges and freezers with no or extremely delayed external alarms. Lab appliances with an alarm interface can be connected to an external independent monitoring system. This allows a high degree of safety for valuable temperature-sensitive contents.

Hygiene

In order to be able to easily maintain the hygiene standards in a laboratory environment, Liebherr laboratory appliances are usually equipped with adjustable feet or castors (in some cases as accessories) to enable cleaning under or behind the appliances. The selected robust materials as well as the easy cleaning design contribute to optimum hygiene in operation. Liebherr laboratory appliances can be incorporated into the hygiene routine with common disinfectants (see chapter on cleaning).

Design

Liebherr laboratory fridges/freezers are designed for daily use, i.e. for frequent door opening, the shelves for higher weight loads, the refrigeration technology is designed for tougher operational requirements, etc. In addition, laboratory appliances offer an access code as standard to protect stored goods from misuse. Apart from the functional aspects, lab appliances are designed to suit typical lab working environments, particularly relevant for under-bench appliances.

Certifications

For certain applications, it is essential to comply with the required guidelines with regard to appliance design. For example, for the storage of highly flammable materials, an ATEX compliant appliance must be used to guarantee safety in operation. DIN 58345 compliant devices ensure that medicines are stored in such a way that the effectiveness of the contents is maintained. All laboratory appliances can be integrated into the existing quality management system through qualification (IQ/OQ/PQ). The individual adaptability of the appliances supports this process.

Depending on their intended use, Liebherr laboratory and pharmacy fridges and freezers can be divided into the following areas of application:

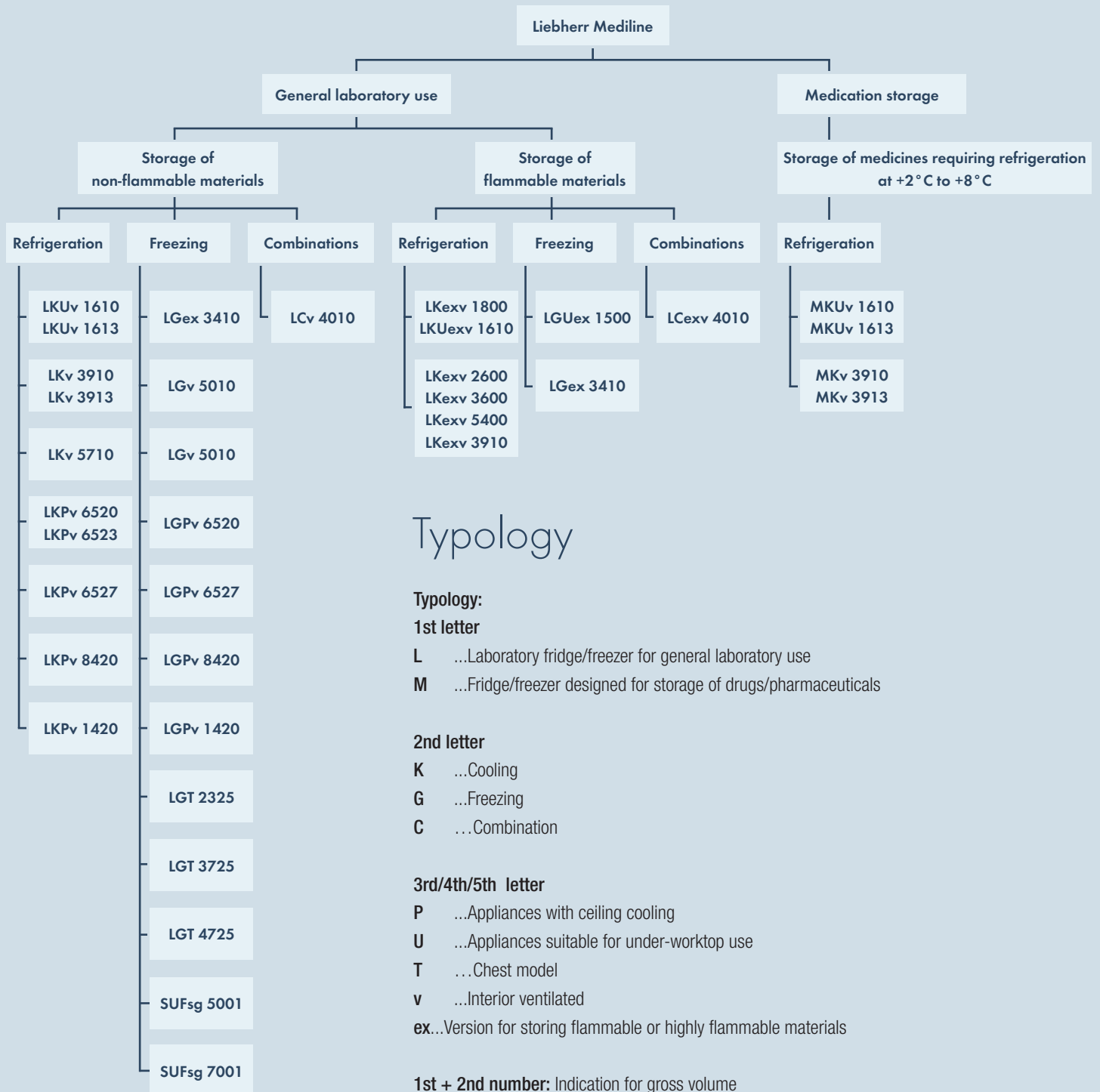

Typology

Typology:

1st letter

- L** ...Laboratory fridge/freezer for general laboratory use
- M** ...Fridge/freezer designed for storage of drugs/pharmaceuticals

2nd letter

- K** ...Cooling
- G** ...Freezing
- C** ...Combination

3rd/4th/5th letter

- P** ...Appliances with ceiling cooling
- U** ...Appliances suitable for under-worktop use
- T** ...Chest model
- v** ...Interior ventilated
- ex**...Version for storing flammable or highly flammable materials

1st + 2nd number: Indication for gross volume

3rd + 4th number: Special identification of appliance version (electronics/lighting)

SUFsg 5001 / 7001

- S** ...Scientific
- U** ...Ultra-low temperature
- F** ...Freestanding
- s** ...Static cooling
- g** ...Electronic version
- 50/70** ...500/700 litres
- 01** ...Insulated door

General laboratory use

For storage of samples, materials requiring refrigeration, biomaterials, product tests, etc. in a temperature range from +16°C to -86°C. Fields of application: general laboratories, universities, research institutes, industry, etc. The devices are not suitable for operation in potentially explosive atmospheres.

Storage of explosive or highly flammable materials:

Specially designed for storage of explosive and highly flammable substances in the chemical industry or in special laboratories, Liebherr fridges and freezers have a spark-free interior. The interior of the appliance complies with the safety requirements of the EU Directive 2014/34/EU (ATEX 114) and is tested according to the standards EN 1127-1 and IEC 60079-0 or IEC 60079-7. Due to the classification II 3G Ex nA IIB+H2 T6 (LKUexv/LKexv) or II 3G Ex nA IIC T6 (LGUex/LGex) the appliances are suitable for the storage of explosive and highly flammable substances in closed containers. Fields of application: general laboratories, universities, research institutes, industry, etc. The appliances are not suitable for operation in potentially explosive atmospheres.

The user is responsible for the correct storage of their materials. This includes checking whether the explosion group specified on the material for storage also corresponds to the explosion group on the appliance; materials in a lower explosion group can also be stored in an appliance with a higher explosion group. In addition, the user must also consider the maximum storage quantity and the combined storage of different substances.

The relevant information must be taken from the safety data sheets of the respective materials/products or obtained directly from the manufacturer of the materials/products.



The devices are marked with a sticker on the door with the respective ATEX class and the cleaning instructions.

Why should a spark-free appliance be used?

When storing flammable or highly flammable materials, it is possible - even if they are stored in closed containers - for gases to escape. In unfavourable cases, these can develop into an explosive air-gas mixture. An ignition spark, which can be caused, for example, by non-ATEX compliant components, ignites the mixture and can lead to a dangerous situation due to the explosion.



Source: Michigan State University



Source: Sun Media Ltd



Source: University of Texas Austin

Storage of medicines/pharmaceuticals

Fridges for use in pharmacies, hospitals and doctors' surgeries must meet particularly high requirements for the storage of medicines requiring refrigeration in the temperature range from +2°C to +8°C.

The Liebherr MKUv/MKv pharmacy fridges in accordance with DIN 58345 therefore have numerous functions and features to provide the best possible protection for high-quality preparations and sensitive medicines. The fixed set temperature of +5°C ensures that the actual spatial and temporal temperature fluctuation in the appliance does not fall below or exceed the limits of +2°C and +8°C.

The appliances are not suitable for operation in potentially explosive atmospheres.



MKv 3910 variant H63



MKv 3910



MKUv 1610 variant H63



MKUv 1610

Alarm, memory and safety functions depending on the model

Liebherr MediLine fridges and freezers help to protect your stored goods. They offer a wide range of alarm, storage and safety functions that have been developed to significantly reduce the risk of loss of stored goods.

Temperature, door open and power failure alarm

High/low temperature alarm

All MediLine models for general laboratory use that are equipped with an electronic control system have an integrated high/low air temperature alarm with both audible and optical signalling. The factory setting of the alarm limits is $+3/-3^{\circ}\text{C}$ in relation to the set temperature. If this is changed to meet a specific storage temperature requirement, the alarm settings automatically adapt accordingly and do not need to be set separately. To avoid unwanted alarms, for example from door openings, these appliances have a temperature alarm delay of 15 minutes. To meet individual requirements, however, the alarm parameters can be set by the user.

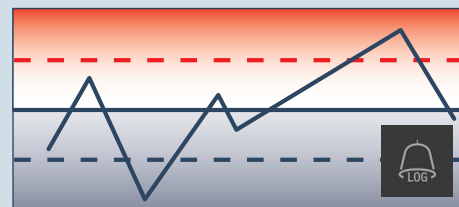

Door open alarm

All MediLine models with electronic control register when the door is left open or not completely closed. They signal this by means of an integrated audio and visual door-open alarm. This alarm has a delay time of 1 minute and can be extended to 5 minutes as needed.



Power failure alarm

In the event of a power failure lasting more than 1 minute and if the set high-temperature alarm is exceeded, all MediLine models with electronic controller trigger an optical power failure alarm when the power returns. The power failure alarm is maintained until it is manually reset.

All LKPv and LGPv models as well as MKUv/MKv and SUFsg models are additionally equipped with a self-charging battery that immediately triggers a visual and audio alarm in the event of a power failure. Both the integrated temperature data memory and the external temperature monitoring system – with the option of being connected via the RS 485/LAN (SUFsg) interface – continue their function for up to 72 hours during a power failure.

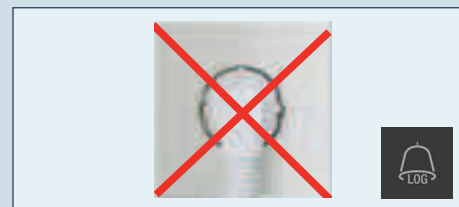

Alarm notifications for controller malfunctions/faults

The following alarm is in conjunction with the internal self-monitoring of the electronic sensors. Although this alarm does not appear directly relevant in the daily use of the appliances, it offers additional safety by ideally warning the user before the air temperature sensor registers an alarm condition.

Alarm in case of malfunction of the temperature sensors

As a self-monitoring system, the appliance detects defective temperature sensors, whereupon the electronics trigger an audible and optical alarm signal. In the event of a defective control sensor, the electronics have a preset operating mode that constantly maintains the internal temperature of fridges at + 5 °C and of freezers at - 20 °C.



Internal memory functions

Internal alarm data memory ('alarm log')

This function stores details of the last three temperature and power failure alarm events. It records the date and time of occurrence and the duration of the alarm event. Together with the min/max memory, it allows statements to be made regarding the further use of the stored goods in the event of an alarm message.



Internal min./max. temperature data memory

After the set temperature is reached for the first time, the electronic controllers start to continuously store the highest and lowest registered indoor temperature. These minimum and maximum temperature values can be read from the memory on the display. After the values have been viewed, they can either be left in the memory or deleted. Normally the user records these values and deletes the memory to record data for the next period. The electronic controllers also register the time elapsed since the last reset was carried out up to a period of approx. 41 days. For the SUFsg models, the entire temperature history including alarm notifications can also be read out via the USB interface.



Special safety function

Electromechanical +2 °C safety thermostat for laboratory fridges

To ensure maximum reliability, the electronic controllers are equipped with a high-performance compressor relay, which significantly reduces the probability of a burnt-out relay contact occurring. However, should a defect occur, an additional safety thermostat supports the electronic controllers to prevent the product temperature from falling below +2°C.

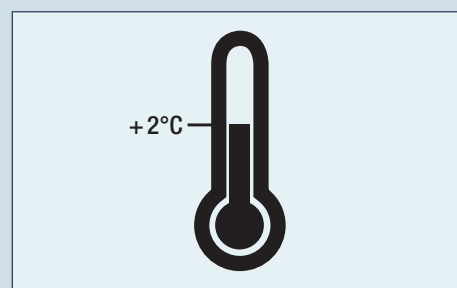

Temperature and alarm documentation

Liebherr MediLine fridges and freezers help to protect your stored goods.

These appliances offer a wide range of features and options that have been developed to externally monitor interior temperatures, product temperatures and alarm events, in order to significantly reduce the risk of loss of stored goods.

Connection for external temperature and alarm monitoring

RS 485 interface and optional interface converter

Models with an integrated RS485 interface can output data to external devices using the standard Modbus RTU protocol. If a monitoring system to be connected via the RS 485 interface is not already available, an interface converter retrofit kit including recording software is available as an optional accessory. It converts the RS 485 signals into RS 232 signals, allowing a connection to a PC or laptop to be established. With the integrated Liebherr LTM software, temperature and alarm recording can be done locally. A maximum of 20 devices can be connected in series.



Protection and safety for professional appliances

With SmartMonitoring, Liebherr offers individual and comprehensive solutions for monitoring professional fridges and freezers. Reliable connectivity components and the use of Cloud services mean that measurement values and operating data can be retrieved and evaluated at any time – with a maximum of data security. If any limits are exceeded, you are immediately informed and can take swift action. The licence-based SmartMonitoring modules are adapted to your needs and can be used both as a comprehensive solution for connectible Liebherr devices and for devices made by other manufacturers.

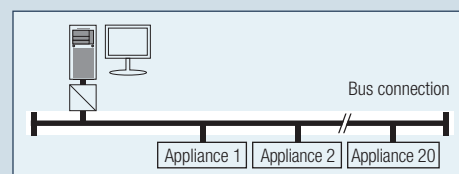

Connection contact for external alarm system

Volt-free alarm contact

All models with an electronic control system have a volt-free contact. This relay contact can be integrated into an existing warning system which, for example, notifies security personnel or a facility caretaker outside working hours. Warning systems can be designed with an audible or optical alarm.

The following example shows a circuit with an optical alarm. It is possible to display normal operation, the alarm state, or both simultaneously. Furthermore, the circuits can be operated with either direct or alternating current. The connection is designed for a maximum of 42 V / 8 A direct current from a SELV safety extra-low voltage source (minimum current 150 mA).

Example: Optical alarm system using the volt-free alarm contact



If there is no in-house warning system and the installation of additional cables in the building is problematic, the volt-free contact can be used, for example in connection with a GSM dialler. There are many different versions of GSM alarm diallers, which either call a phone number and/or send a text message in the event of an alarm. Depending on the characteristics of the dialler, it may be possible to connect several laboratory appliances to one dialler. Use of a GSM dialler requires only a SIM card and a network connection.

The following example shows a circuit with GSM dialler. A change of the relay setting activates the alarm function of the dialler, triggering either a phone call or the sending of a predefined text message to a predefined number. The dialler shown as an example has 6 allocated alarm inputs. These can be used to connect 6 individual appliances or to connect 6 rooms in which multiple appliances are connected in series.

Example: GSM alarm system using the potential-free contact

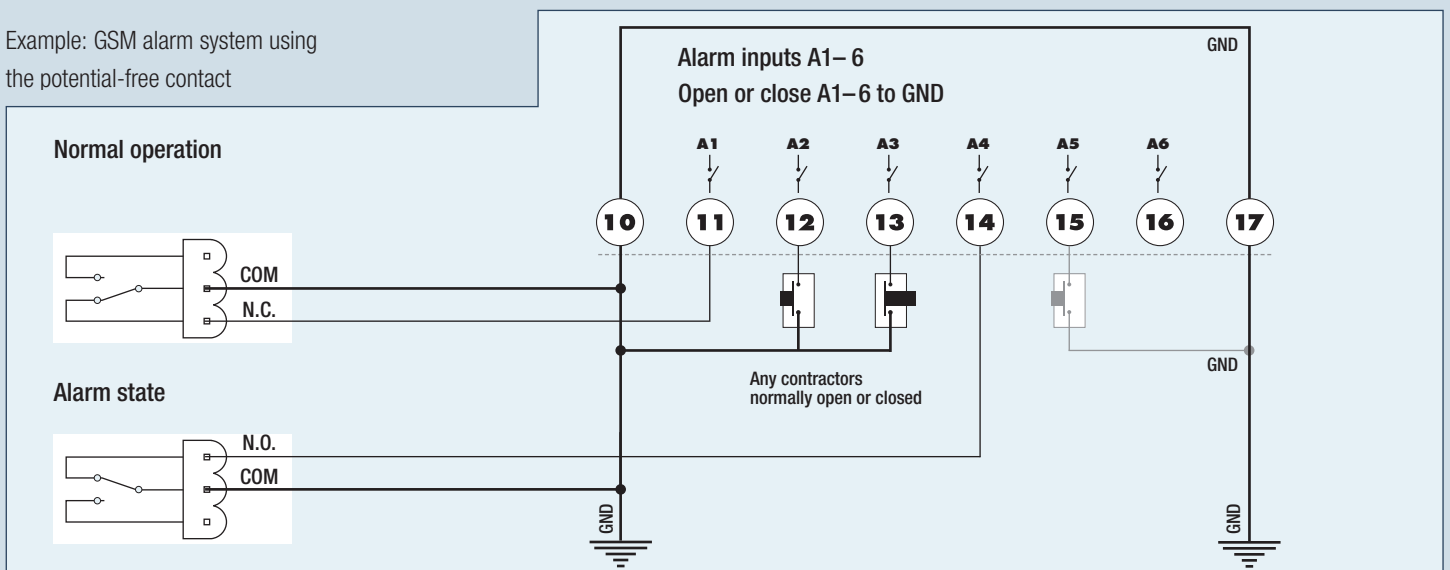

Despite all efforts to produce highly reliable laboratory appliances, Liebherr strongly recommends that the volt-free contact be connected to an independent external warning system. The cost of such a warning system is often insignificant compared to the value of the stored goods.

Connection for product temperature monitoring

Interface for optional NTC product temperature sensor

All LKPv, LGPv, LG(U)ex, LC(ex)v and LGT models have an integrated interface for connecting an optionally available NTC product temperature sensor to the electronics. The electronic display can be set to show either the internal temperature measured by the control sensor or the “product” temperature registered by the product sensor. Based on this selection, the temperature alarm limits refer to either the control sensor or the product sensor.

In addition, the “product” temperature can be transmitted to an external documentation system via the existing RS 485 interface.

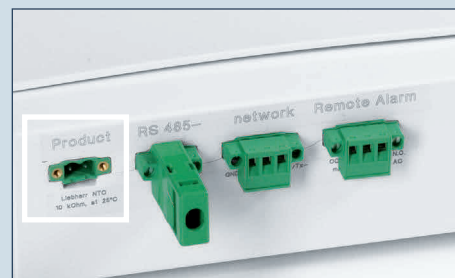

While the control sensor is in a fixed position, the product sensor for simulating the product temperature can be freely positioned in the interior by the user, for example in a vial or in a measuring package. The product sensor is waterproof (IP 68) and its outer sheath is corrosion-resistant (AISI 316). It meets all NSF standards.



Due to possible tolerances of the optional product temperature sensor, the displayed product temperature may differ from the product sensor temperature. With the calibration function, the displayed product temperature can be compared to the product sensor temperature. The correction value for compensating for the differences can be set in 0.1°C steps.

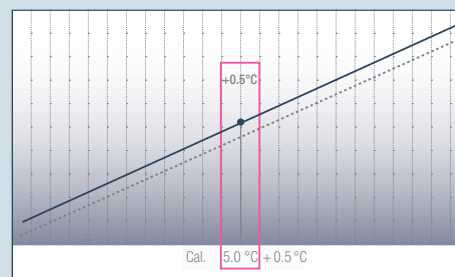

Access port for the installation of independent temperature recording systems

The laboratory appliances have an access port (diameter 7-10 mm) to allow integration of a temperature sensor in the interior. This allows the appliances to be easily connected to an existing temperature recording system without having to drill destructive holes in the housing.



Pharmacy fridges compliant with DIN 58345

For pharmacy fridges in accordance with DIN 58345, the following adjustments were made to the corresponding laboratory fridges LKUv/LKv in order to comply with DIN 58345:

- The temperature range is fixed at +5°C and cannot be changed
- No adjustability of offset values of the sensors
- No adjustability of alarm limits (+2°C and +8°C)
- Additional integrated product temperature sensor
- Standard integrated evaporator cover prevents freezing of medicines positioned close to the evaporator
- Permanently installed electricity failure alarm warns in case of unnoticed power failures and maintains the electronic temperature recording to be able to continue recording the temperature profile

Note:

Pharmacy fridges are not medical devices in the sense of MDD (93/42/ECC) or MDR (EU/2017/745)

Overview of safety features

Laboratory appliances	LKPv 6520	LKPv 6523	LKPv 8420	LKPv 1420	LKPv 1423	LGPv 6520	LGPv 8420	LGPv 1420
Electronic controller	○	○	○	○	○	○	○	○
Temperature display	○	○	○	○	○	○	○	○
High/low temperature alarm, audio and visual	○	○	○	○	○	○	○	○
Door alarm, audio and visual	○	○	○	○	○	○	○	○
Power failure alarm after power return, optical	○	○	○	○	○	○	○	○
Power failure alarm immediately upon power failure	○	○	○	○	○	○	○	○
Alarm notifications for controller malfunctions/faults	○	○	○	○	○	○	○	○
Internal alarm data memory ('alarm log')	○	○	○	○	○	○	○	○
Internal min./max. temperature data memory	○	○	○	○	○	○	○	○
Electromechanical +2°C safety thermostat for laboratory fridges	×	×	×	×	×	×	×	×
RS 485 interface and optional interface converter	○	○	○	○	○	○	○	○
Volt-free contact	○	○	○	○	○	○	○	○
Interface for optional NTC product temperature sensor	○	○	○	○	○	○	○	○
Access port for the installation of independent temperature recording systems	○	○	○	○	○	○	○	○
Design according to DIN 58345 - Storage of medicines	×	×	×	×	×	×	×	×
Spark-free interior	×	×	×	×	×	×	×	×

○ standard × not available / not applicable

Overview of safety features

Laboratory appliances	LKUv 1610	LKUv 1613	LKUexv 1610	LGUex 1500	LKv 3910	LKv 3913	LKv 5710	LKexv 3910	LGex 3410	LGv 5010	LCv 4010	LCexv 4010
Electronic controller	○	○	○	○	○	○	○	○	○	○	○	○
Temperature display	○	○	○	○	○	○	○	○	○	○	○	○
High/low temperature alarm, audio and visual	○	○	○	○	○	○	○	○	○	○	○	○
Door alarm, audio and visual	○	○	○	○	○	○	○	○	○	○	○	○
Power failure alarm after power return, optical	○	○	○	○	○	○	○	○	○	○	○	○
Power failure alarm immediately upon power failure	×	×	×	×	×	×	×	×	×	×	×	×
Alarm notifications for controller malfunc- tions/faults	○	○	○	○	○	○	○	○	○	○	○	○
Internal alarm data memory (‘alarm log’)	○	○	○	○	○	○	○	○	○	○	○	○
Internal min./max. temperature data memory	○	○	○	○	○	○	○	○	○	○	○	○
Electromechanical +2°C safety thermostat for laboratory fridges	○	○	○	×	○	○	○	○	×	×	×	×
RS 485 interface and optional interface converter	○	○	○	○	○	○	○	○	○	○	○	○
Volt-free contact	○	○	○	○	○	○	○	○	○	○	○	○
Interface for optional NTC product temperature sensor	×	×	×	○	×	×	×	×	○	○	○	○
Access port for the installation of independ- ent temperature recording systems	○	○	○	○	○	○	○	○	○	○	○	○
Design according to DIN 58345 - Storage of medicines	×	×	×	×	×	×	×	×	×	×	×	×
Spark-free interior	×	×	○	○	×	×	×	○	○	○	×	○

○ standard × not available / not applicable

Overview of safety features

Laboratory appliances LKexv with analogue controls and spark-free interior	LKexv 5400	LKexv 3600	LKexv 2600	LKexv 1800
Electronic controller	×	×	×	×
Temperature display	○	○	○	○
High/low temperature alarm, audio and visual	×	×	×	×
Door alarm, audio and visual	×	×	×	×
Power failure alarm after power return, optical	×	×	×	×
Power failure alarm immediately upon power failure	×	×	×	×
Alarm notifications for controller malfunctions/faults	×	×	×	×
Internal alarm data memory ('alarm log')	×	×	×	×
Internal min./max. temperature data memory	×	×	×	×
Electromechanical +2°C safety thermostat for laboratory fridges	×	×	×	×
RS 485 interface and optional interface converter	×	×	×	×
Volt-free contact	×	×	×	×
Interface for optional NTC product temperature sensor	×	×	×	×
Access port for the installation of independent temperature recording systems	×	×	×	×
Design according to DIN 58345 - Storage of medicines	×	×	×	×
Spark-free interior	○	○	○	○

○ standard × not available / not applicable

Overview of safety features

Medication fridges as per DIN 58345	MKv 3910	MKv 3913	MKUv 1610	MKUv 1613	MKv 3910 Variant H63	MKv 3913 Variant H63	MKUv 1610 Variant H63	MKUv 1613 Variant H63
Electronic controller	○	○	○	○	○	○	○	○
Temperature display	○	○	○	○	○	○	○	○
High/low temperature alarm, audio and visual	○	○	○	○	○	○	○	○
Door alarm, audio and visual	○	○	○	○	○	○	○	○
Power failure alarm after power return, optical	○	○	○	○	○	○	○	○
Power failure alarm immediately upon power failure	○	○	○	○	○	○	○	○
Alarm notifications for controller malfunc- tions/faults	○	○	○	○	○	○	○	○
Internal alarm data memory (‘alarm log’)	○	○	○	○	○	○	○	○
Internal min./max. temperature data memory	○	○	○	○	○	○	○	○
Electromechanical +2°C safety thermostat for laboratory fridges	○	○	○	○	○	○	○	○
RS 485 interface and optional interface converter	○	○	○	○	○	○	○	○
Volt-free contact	○	○	○	○	○	○	○	○
Interface for optional NTC product temperature sensor	×	×	×	×	×	×	×	×
Access port for the installation of independ- ent temperature recording systems	○	○	○	○	○	○	○	○
Design according to DIN 58345 - Storage of medicines	○	○	○	○	○	○	○	○
Spark-free interior	×	×	×	×	×	×	×	×

○ standard × not available / not applicable

Overview of safety features

Laboratory chest freezers to -45 / -86 °C	LGT 2325	LGT 3725	LGT 4725	SUFsg 5001	SUFsg 7001
Electronic controller	○	○	○	○	○
Temperature display	○	○	○	○	○
High/low temperature alarm, audio and visual	○	○	○	○	○
Door alarm, audio and visual	○	○	○	○	○
Power failure alarm after power return, optical	○	○	○	○	○
Power failure alarm immediately upon power failure	○	○	○	○	○
Alarm notifications for controller malfunc- tions/faults	○	○	○	○	○
Internal alarm data memory (‘alarm log’)	○	○	○	○	○
Internal min./max. temperature data memory	○	○	○	○	○
Electromechanical +2°C safety thermostat for laboratory fridges	×	×	×	×	×
RS 485 interface and optional interface converter	○	○	○	LAN	LAN
Volt-free contact	○	○	○	○	○
Interface for optional NTC product temperature sensor	○	○	○	×	×
Access port for the installation of independ- ent temperature recording systems	○	○	○	○	○
Design according to DIN 58345 - Storage of medicines	×	×	×	×	×
Spark-free interior	×	×	×	×	×

○ standard × not available / not applicable

Controllers and functions

The electronic controller provides the functions required for the purpose of storing temperature-sensitive products. Due to the individual adjustability of various parameters, the appliance can be adapted to specific user requirements.





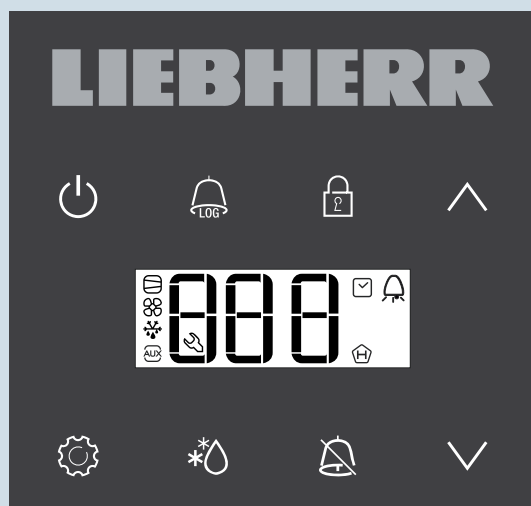

Operating and control elements of the electronic controller (not valid for SUFsg models)

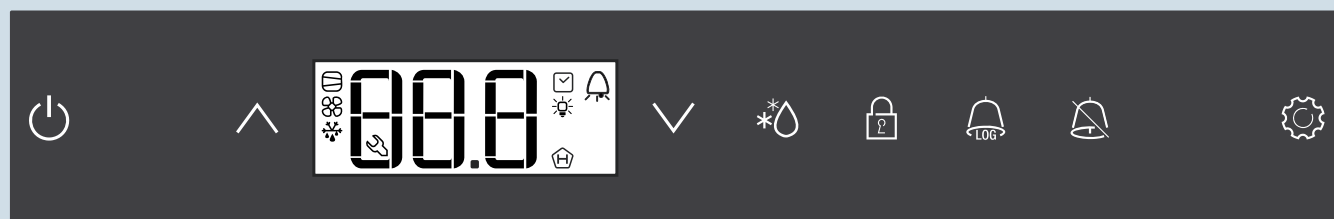
LKPv / LGPv:













LK(U)(ex)v / LG(U)(ex)v / LC(ex)v / MK(U)v:



-  On/Off button (switching the appliance on and off)
-  Button for calling up stored alarm events
-  Keypad lock
-  Selection buttons
-  Audible alarm Off button
-  Defrost button (for manually activating the defrost function)
-  Enter button

Symbols in the display

-  Compressor is running
-  LED flashing - refrigeration unit switches on after a delay. The compressor will start automatically after the pressure in the refrigerant circuit has equalised.
-  Fan is running
-  Appliance is defrosting
-  Temperature display via product sensor is activated
-  LED flashing and ETC appears in the display. The real time clock must be reset.
-  The H icon display means that the power supply and interior temperature of the appliance are recorded.
-  If H icon flashes in the display, there has either been a power failure or the temperature in the appliance exceeded the permissible range.
-  Alarm function
-  The appliance has suffered a fault. Contact the customer service department.

Controller function overview (can vary by model):

Appliance on/off

Appliance is in standby mode during initial start-up

Setting the temperature

Adjustable depending on the type of appliance. In the range from -19.9°C to +16.0°C in 1/10°C increments, from -20°C to -45°C in 1°C increments.

Display °C/°F

Depending on the region, the appliances can be switched to °F, factory setting °C.

Door open alarm with adjustable delay

The alarm delay after the door is opened can be set between 1 and 5 minutes.

Activating/deactivating audio alarms

In certain applications, the audio alarm can be completely deactivated. The alarm messages are then only visible on the appliance display and via the interfaces.

Audio alarm reactivation

With the factory setting, the audio alarm remains muted after acknowledgement. If the audible alarm is to be reactivated while the alarm condition is still ongoing, a reactivation time between 1 and 120 minutes can be configured.

Alarm test function

The test function is used to check the functionality of the internal and any externally connected alarm system. The cooling of the appliance is not interrupted during this test run.

Setting alarm parameters

(Over/under temperature alarm and delay)

The alarm limits (difference to the set temperature) and the alarm delay (time delay until the alarm is triggered) can be adapted to individual conditions.

Recalling the stored alarm conditions

It is possible to read out the last three temperature alarms and power failure alarms during which the set temperature alarm limit was exceeded for longer than 1 minute, along with the precise time and duration.

Reading out the minimum and maximum temperatures that have occurred

The minimum and maximum temperature that occurred in the appliance can be recorded for a period of 999h (approx. 41 days). After that, the last value is overwritten. The recording period can be reset at any time.

Calibration of the control probe

Possible tolerances of the control probe (set temperature to actual internal temperature) can be compensated with this function. For this purpose, an external calibrated measuring device is positioned in the interior of the appliance and the temperature is recorded over a specific period of time (a period of at least 12h is recommended). The average temperature value determined from this measurement may deviate from the set temperature. This deviation can be corrected by adjusting the offset value of the controller.

Calibration of the product probe

see calibration of the control probe.

Display of control probe or product probe

The value shown on the display can be switched between the control probe and the product probe (if installed). The alarm limits always refer to the sensor shown on the display.

Key lock

To prevent unintentional changes to the controller configuration the keypad can be locked with a three-digit numerical code. In this case only the alarms can be acknowledged. This means that only authorised personnel can make changes to parameter values. If the code is forgotten or lost, the controller can be reset to the factory setting.

Setting the real-time clock

If the appliance is used in different time zones, it may be necessary to set the integrated real-time clock to the current time zone. This ensures that the stored alarms match the local time. The factory setting shows the Central European Time Zone CET.

Activation of automatic summer/winter time

In many regions there is a time shift due to summer/winter time. To adjust the real-time clock automatically to this, automatic time shift can be activated. The shift to summer time takes place automatically in the electronics on the last Sunday in March at 2 a.m. The shift to winter time takes place automatically in the electronics on the last Sunday in October at 2 a.m.

Changing the network address

If multiple appliances are connected to one bus connection (up to 20 appliances possible), the individual appliances must be assigned separate addresses for identification in the network.

Controller function overview (can vary by model):

Activation of the interior light

For quick recognition of the stored goods, the LED interior light can be permanently activated for glass door models.

Display selection during defrosting

During an automatic defrost, the electronic display can show various display options. During a defrost, the appliance door should remain closed to prevent an unnecessary temperature rise. The following options are available: Defrost icon and alternating display of 'dEF' with current internal temperature, defrost icon and temperature before start of defrosting (factory setting), defrost icon and display 'dEF'.

Manual defrost

Defrosting takes place automatically. The defrost water drains into an vapouriser tray in the compressor compartment and evaporates using the compressor heat. If the door was not closed properly for a longer period of time, the interior or the evaporator may be subject to severe frosting. In this case the defrosting function can be activated manually.

Resetting parameters to factory settings

With this function, the alarm limits and values of the sensor calibration as well as the password of the key lock can be reset to factory settings.

If further adjustments to the appliance are necessary for individual use, a modification can be requested via customer service.

Cleaning and disinfection instructions

Cleaning intervals depend on the local conditions as well as the standards specified by the customer. However, the appliance should be cleaned at least twice a year.

Always put the appliance out of operation before cleaning. Unplug the mains plug or trip or remove the upstream fuse. Disconnect any connected uninterruptible power supplies ('UPS').

- Remove stored goods from the appliance and store in a cool place.
- Clean the interior and equipment parts with lukewarm water and a little washing-up liquid.
Never use cleaning agents containing sand particles or acid, and never use chemical solvents.
Do not use steam cleaning equipment! - Risk of damage and injury.
- Care must be taken to ensure that no cleaning water penetrates into the electrical parts and into the ventilation grid.
- Dry everything well with a cloth.
- Use a commercially available stainless steel cleaner for appliances with stainless steel surfaces.

Do not use abrasive/scouring sponges, concentrated cleaners, cleaners containing sand or chloride, acidic cleaners or chemical solvents; this can damage surfaces and cause corrosion.

For appliances with a refrigerating machine mounted close to the floor, the heat exchanger (metal grille) at the rear of the unit should be cleaned or dusted once a year.

Appliances for storing flammable or highly flammable materials:

Warning! Clean plastic parts only with a damp cloth! Risk of electrostatic charge.

Do not damage or remove the serial tag - it is important for customer service.

The following is a non-exclusive list of approved disinfectants:

Designation of disinfectant:	Manufacturer:
Dismozon pure 1 % solution	Bode Chemie
Suma Quicksan	Diversey
Incidin Extra N	Ecolab Healthcare
Acrylan	Antiseptica chem. pharm. products
Buraton 10 F	Schülke und Mayr
Frankocid N	Franken Chemie
Apesin DSR 50	Tana
Nüscosept Spray	Dr. Nüsken
Nüscotan Spezial	Dr. Nüsken
Melsept SF	B. Braun Melsungen
Kohrsolin	Bode Chemie
Neoquat S	Dr. Weigert
Incidin Rapid	Ecolab Healthcare
Bacillocid Spezial	Bode Chemie
Neoform K Spray	Dr. Weigert
Apesin Desinf. Spray	Tana
Nüscosept 100	Dr. Nüsken
Antisept T	Fink Tec
Apesin AP 100 0.5% solution	Tana
Perform powder 2% solution	Schülke und Mayr

However, be aware: Liebherr is not liable for damage caused by improper use of the materials used. The instructions provided by the manufacturers must be strictly observed. Use disinfectants safely. Always read the label and product information before use. Before using the product, please observe the specific application parameters and instructions in the respective manufacturers' product data sheets.

Heat output

Fridges and freezers give off heat to the environment during operation. In order to maintain the functionality of the appliances in closed spaces, the generated heat must be dissipated. For this purpose, the specific heat dissipation is given for each model as a characteristic value for the ventilation design. This can be obtained from Liebherr Service or customer service if required. The specified value is a reference value.

Cable length

Connecting cable lengths

2.8m for models LK(U)(ex)v/LG(U)(ex)(v)/MK(U)v/LC(ex)v

3.0m for SUFsg models

3.8m for models LKPv/LGPv

Note: The power socket must not be located behind the appliance and must be easily accessible. Do not connect the appliance using an extension cable or multi-socket.

Quality test certificate

The quality test certificate represents the temperature and safety test at our test facility and is automatically generated for every Liebherr laboratory fridge/freezer (except LGT). The certificate is a representation of the test results at the time of the final test and therefore has no validity period - it simply documents the condition of the appliance at the time of the test. Depending on the acceptance of the customer's internal quality assurance, this document can facilitate the initial qualification.



Qualität, Design und Innovation

Prüfzertifikat / Testing certificate

Kontaktdaten / contact data

Hersteller / manufacturer: Liebherr Hausgeräte Lienz GmbH
 Website: www.liebherr.com

Gerätedaten / appliance data

Gerät / appliance: LKUv 1610-23A - 001
 Seriennummer / serial number: 831027917
 Produktionsdatum / production date: 02.2015

Testdaten / test data

Sensor: Temperatur 1

Eingestellte Temperatur / set temperature [°C]: +5°C
 Umgebungstemperatur / ambient temperature [°C]: 22.2
 Prüfvorschrift / test instruction: PP_151 (Temperatur- und Leistungsmessung/Performance Test),
 PP_138 (EST nach DIN EN 50106, DIN EN 60333-1, EN 60567, UL250)

Messeinrichtungen / measuring installation: AGRAMKOW TESTBOXEN / EST

Temperaturverlauf - Testergebnis / Temperature course - test result

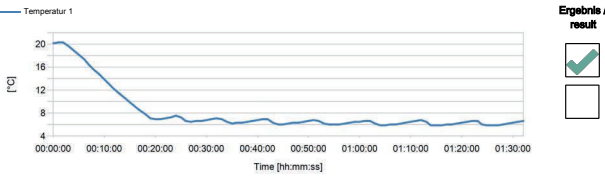

Elektrische Sicherheitsprüfung / electrical safety test:

	Ergebnis / result	
Schutzleiter / protective conductor	90,00	mOhm i.O.
Hochspannung / high voltage	0,00	mA i.O.
Isolationswiderstand / isolation resistance	>3000	MOhm i.O.
Widerstand / resistance		i.O.

Hiermit bestätigen wir, dass das oben genannte Gerät unter Beachtung eines zertifizierten Qualitätssicherungssystems nach DIN EN ISO 9001 geprüft wurde.
 Die für die Prüfung verwendeten Messeinrichtungen werden regelmäßig kalibriert und sind rückführbar auf die nationalen und internationalen Normale. In die Dokumentation kann bei Bedarf eingesehen werden.

We hereby confirm that the above mentioned unit was tested according to DIN EN ISO 9001 under the observation of the certified quality assurance system.
 The measuring installation used for testing is regularly calibrated and is based on the national and international standards. The documentation is available for reference.

Prüfdatum / date of test: 02.2015

Dieses Prüfzertifikat wurde automatisch erstellt und ist ohne Unterschrift gültig.
 This testing certificate was produced automatically and is valid also without signature. 7084 251-00

Appliance temperature performance to IEC 60068

IEC 60068 describes a realistic and reproducible test method for determining the storage conditions in laboratory fridges and freezers.

IEC 60068 consists of three sections:

IEC 60068-1: General information and instructions

IEC 60068-2: Tests

IEC 60068-3: Supporting documentation and instructions

All laboratory fridges and freezers are designed at the modern Liebherr development facilities using the EN 60068 test procedure for measuring temperature stability. You will find the measurement results of the design in the Test results chapter. Please note that these are reference values only. The Liebherr development facility is certified in accordance with the general requirements for the competence of testing and calibration laboratories according to ISO 17025.

Description of the test procedure according to EN 60068

General test conditions

- Ambient temperature +25°C
- 60 % relative humidity
- Set internal temperature for laboratory fridges +5°C
- Set internal temperature for laboratory freezers -20°C
- Set internal temperature for laboratory chest freezers -45°C
- Maximum deviation of the mean temperature value including extended measurement uncertainty for laboratory fridges:
+/- 3K from the set internal temperature
- Maximum deviation of the mean temperature value incl. expanded measurement uncertainty for laboratory freezers and laboratory fridges with mechanical control system: +/-5K from the set internal temperature

The temperature stability measurements are carried out using 9 x PT 100 air temperature sensors. The air temperature sensors are positioned in the interior according to the requirements of standard EN 60068-3.

“Unless otherwise specified, the air temperature sensors are placed in the interior at a distance of 1/10 of the respective interior dimension (height/width/depth) from the walls. The positioning of the air temperature sensors that was determined for the test procedure should represent a typical layout for a workspace.”
In total, eight air temperature sensors are positioned in the corners and one is positioned in the centre of the interior.

Installation of the temperature sensors

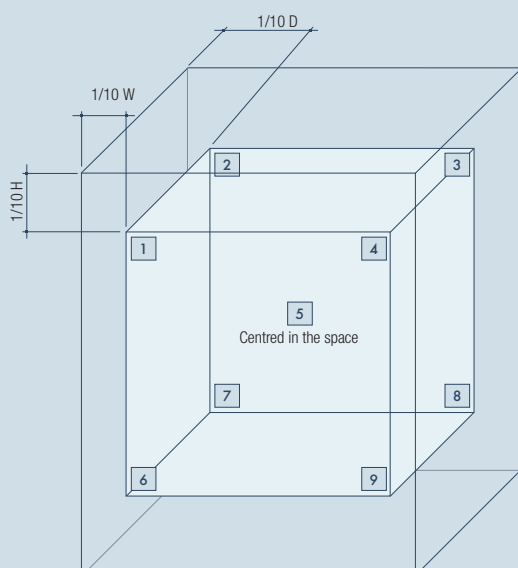

The laboratory appliances are tested in empty condition for a period of 24 hours including defrosting cycles.

Test criteria for assessing temperature consistency and distribution

1) Gradient or homogeneity: "The gradient $H\theta$ is the difference that is achieved in the interior under defined environmental conditions during the measurement period between the mean values on the warmest (max) and coldest (min) measurement channel θ_{mj} , taking into account the expanded measurement uncertainty U_{mj} ."

Gradient (homogeneity) distribution of temperatures in the interior

$$H\theta = \max (\theta_{mj} + U_{mj}) - \min (\theta_{mj} - U_{mj})$$

max = (mean value of warmest measuring channel + expanded measurement uncertainty)
min = (mean value of coldest measuring channel - expanded measurement uncertainty)

Example: Gradient/homogeneity

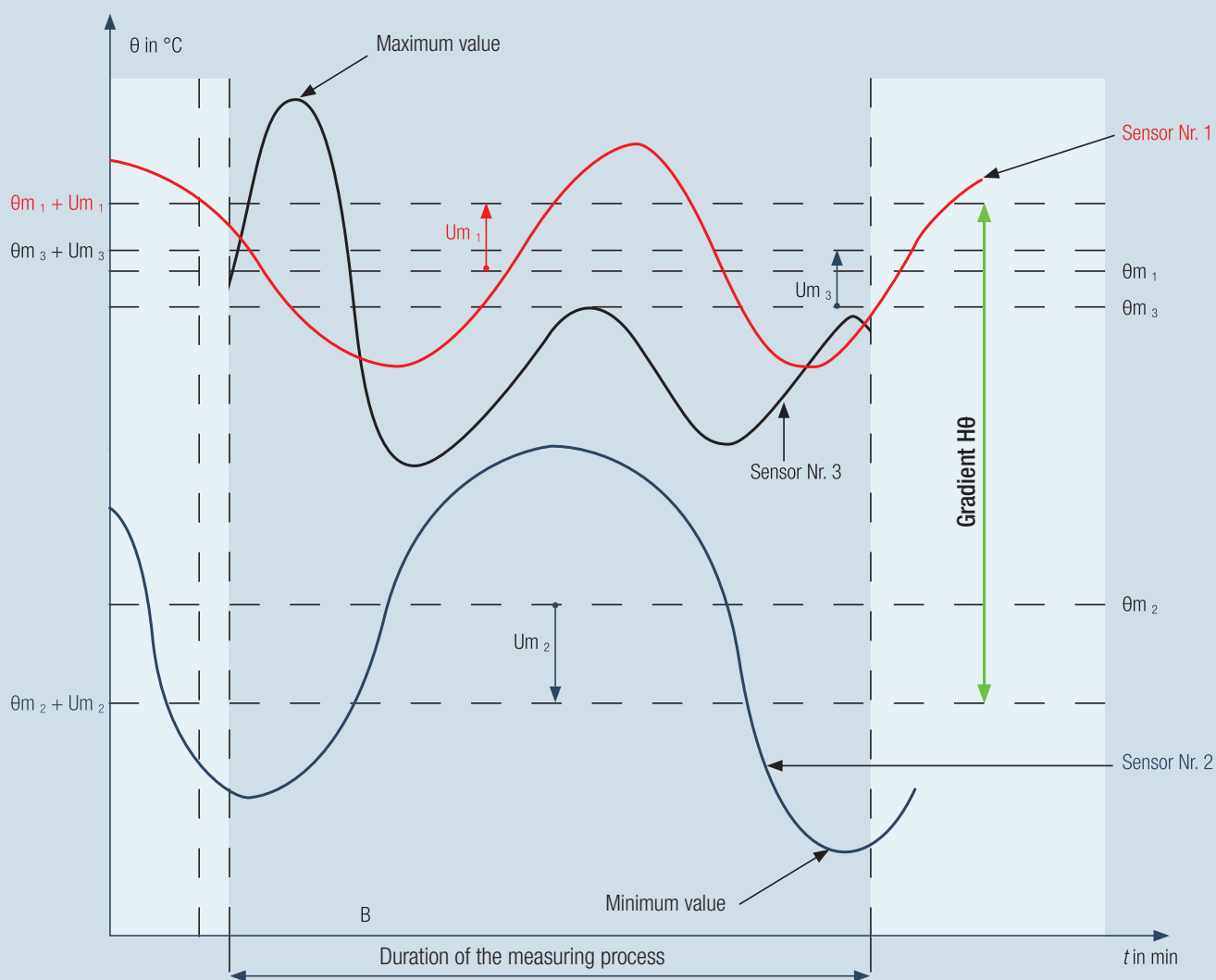

The gradient is an indicator of the temperature distribution within the appliance. Especially in the laboratory, good temperature distribution is essential to ensure that samples and other materials are stored safely at any location in the appliance. The lower the gradient, the better the temperature distribution.

2) Fluctuation: The temperature fluctuation allows the evaluation of the maximum temperature variation at a measuring point in the interior during the measuring period. The following parameters are determined:

- Fluctuation of the measuring point $S\theta_j$: The difference between the maximum and minimum measured temperature values at measuring point j during the measuring period
- Maximum fluctuation $S\theta_m$: Maximum value of all fluctuation values $S\theta_j$ during the measuring period

Fluctuation

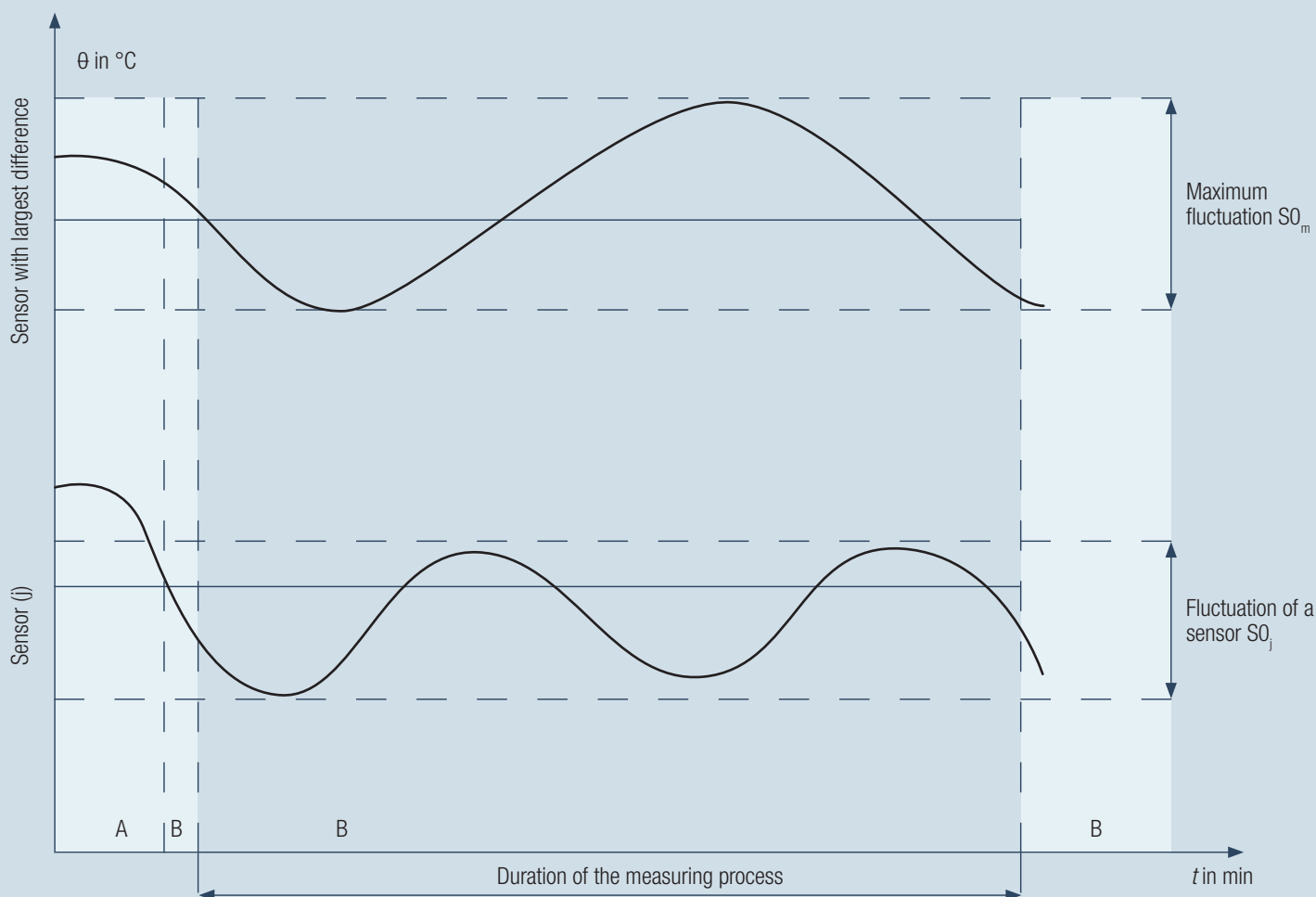

Test results according to EN 60068-3 for laboratory appliances LKpV and LGpV

The evaluation of the air temperatures in the interior according to the test procedure EN 60068-3 measured with PT 100 measuring elements has the following results for the LKpV and LGpV laboratory fridges and freezers:

LKpV 6520

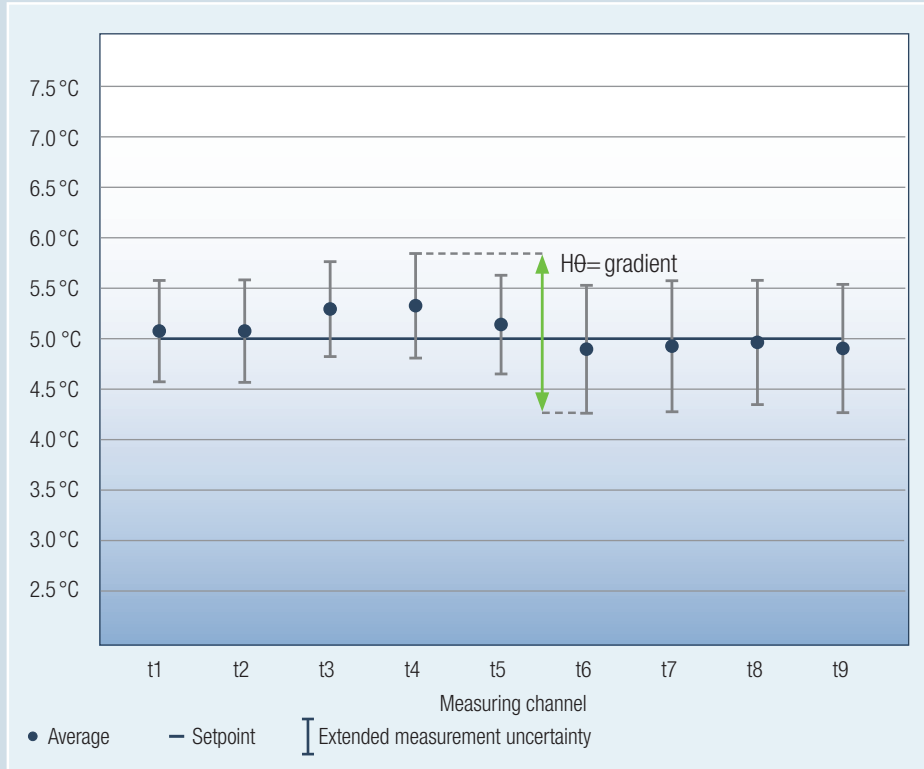

Gradient H_θ- : **1.8 K**

Max. fluctuation: **1.0 K**

LKpV 6523

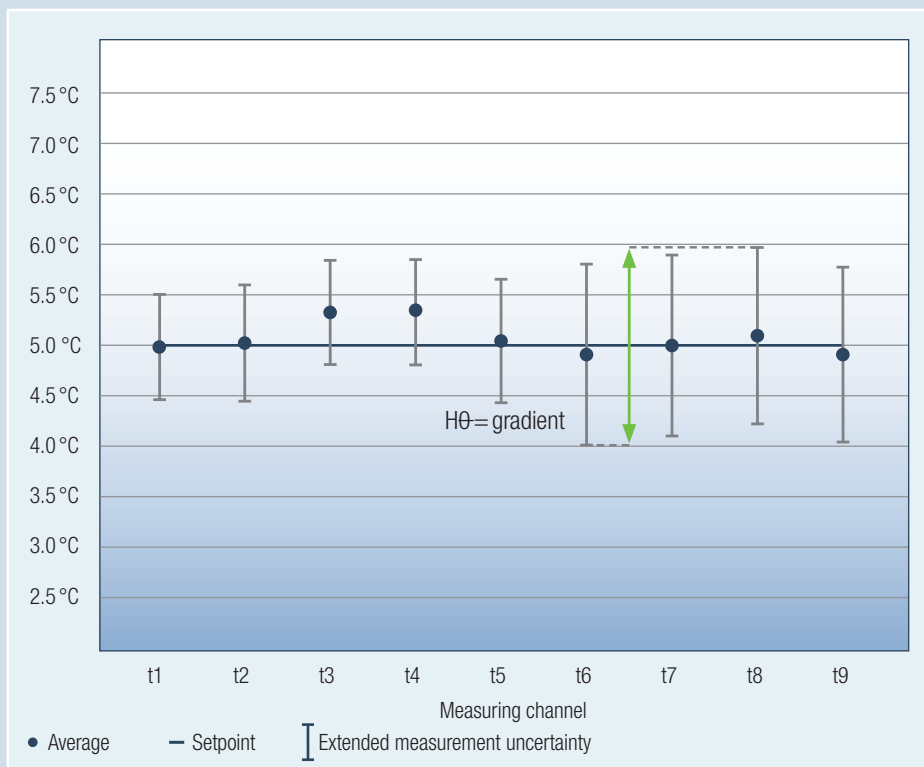

Gradient H_θ- : **2.0 K**

Max. fluctuation: **1.6 K**

LKpV 8420

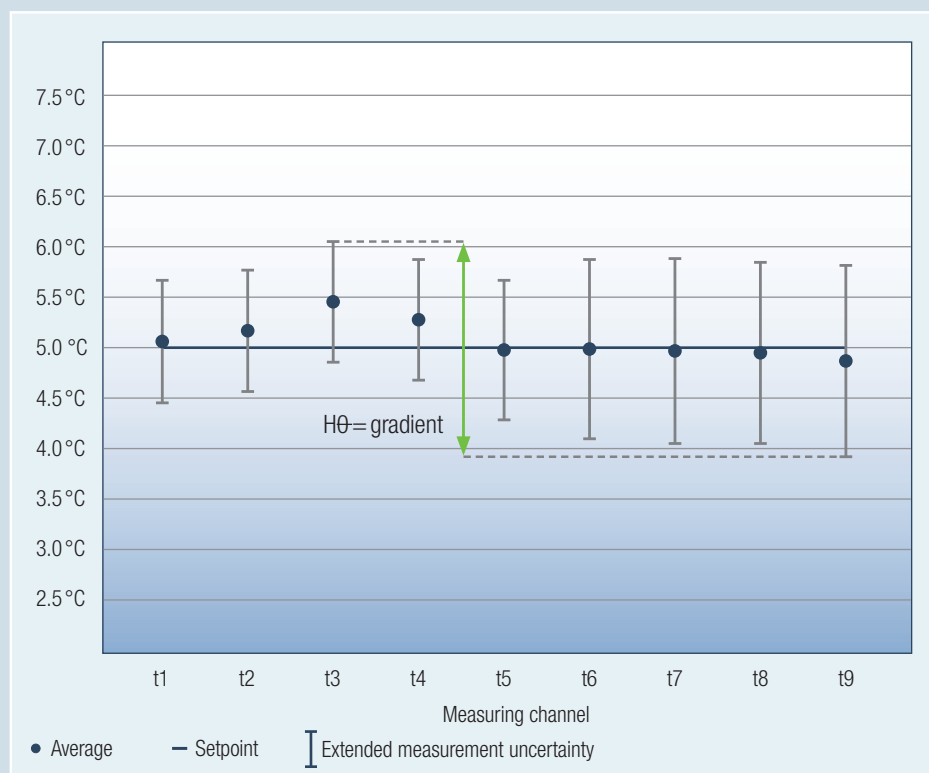

Gradient H0- : **2.1 K**

Max. fluctuation: **1.8 K**

LKpV 1420

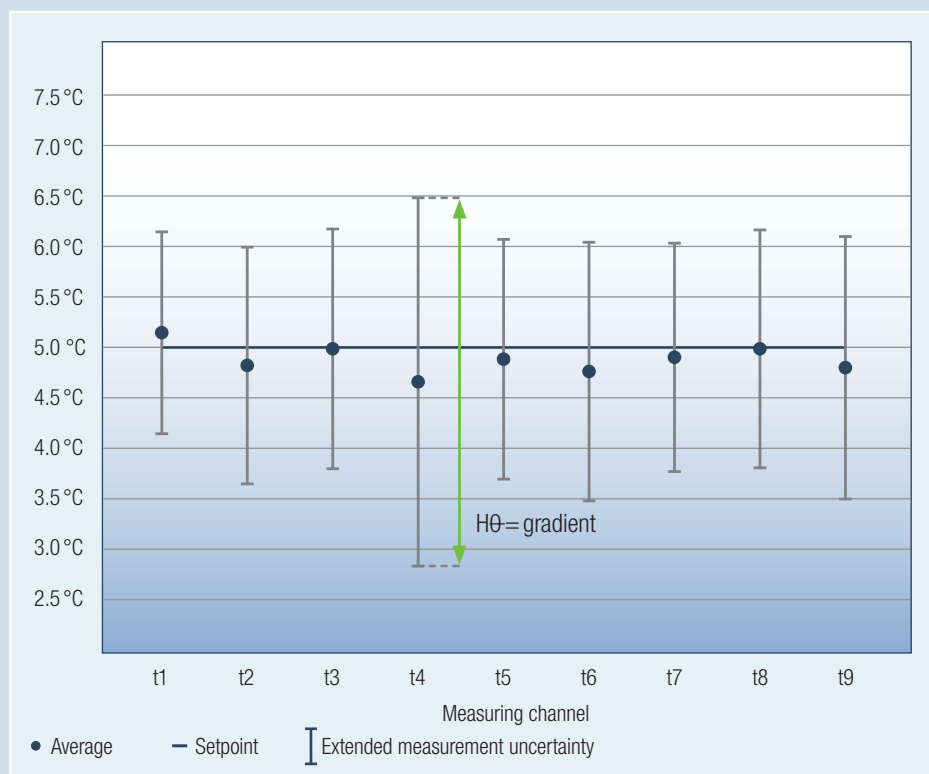

Gradient H0- : **3.6 K**

Max. fluctuation: **2.9 K**

LKpV 1423

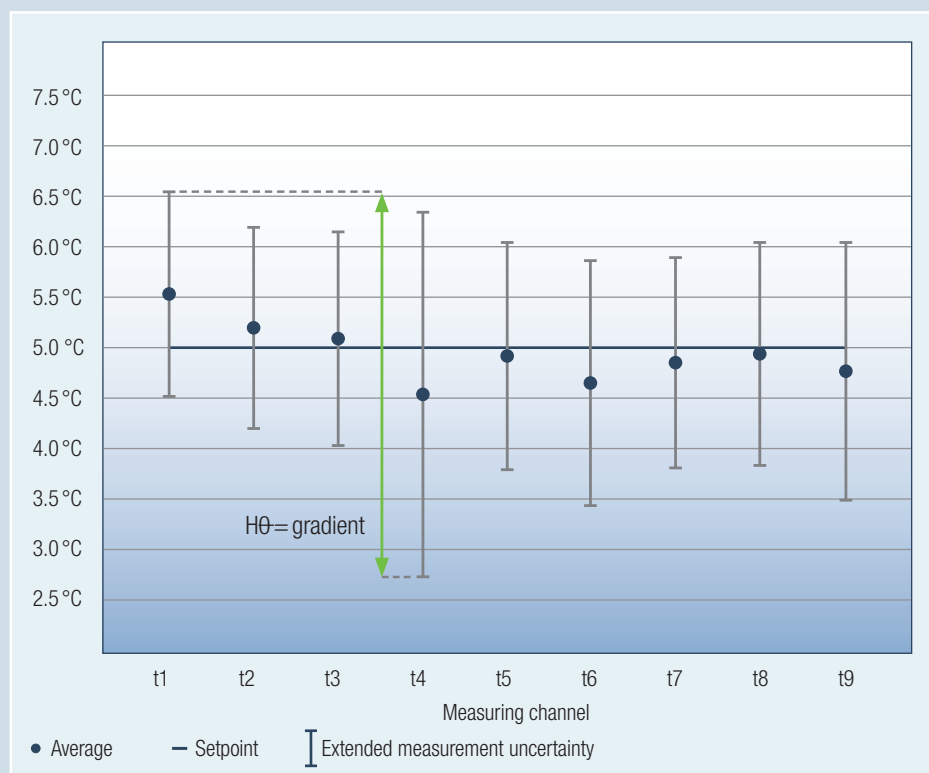

Gradient H0- : **3.8K**

Max. fluctuation: **3.9K**

LGpV 6520

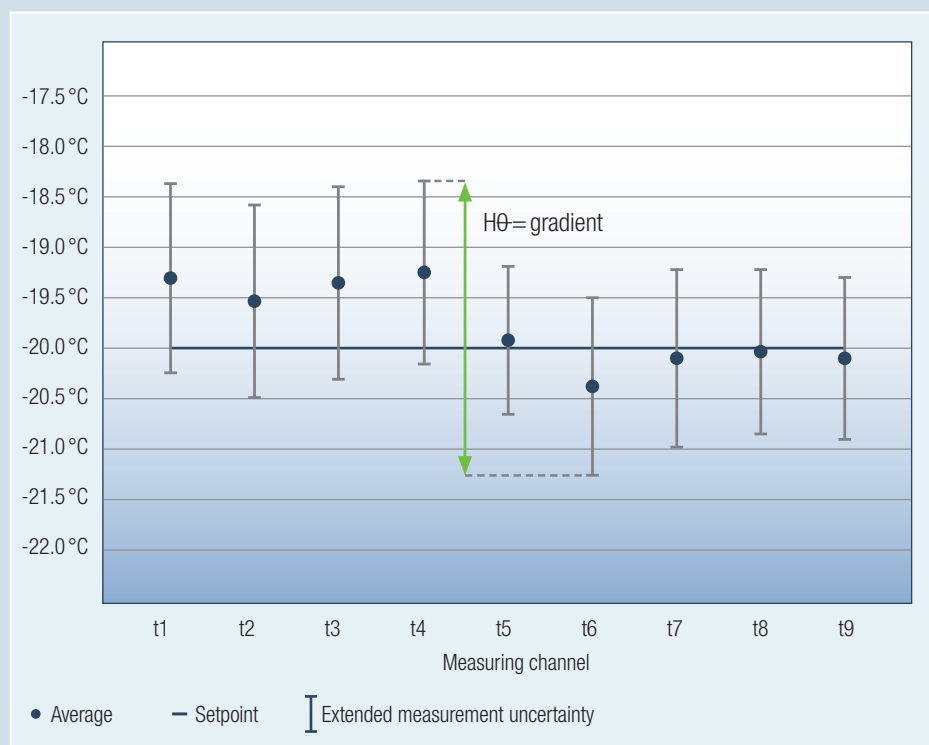

Gradient H0- : **2.9K**

Max. fluctuation: **3.6K**

LGPv 8420

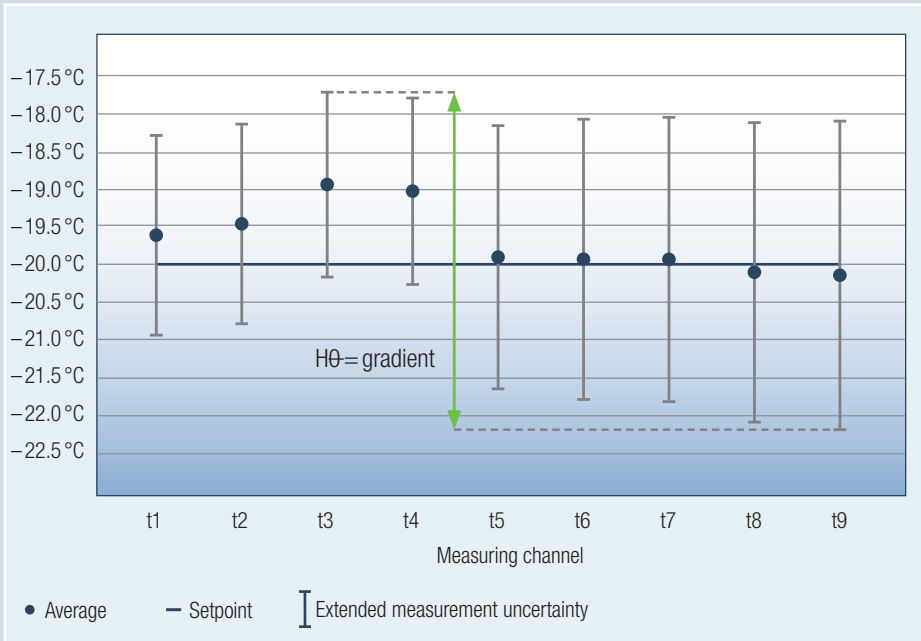

Gradient H0- : **4.5K**

Max. fluctuation: **5.7K**

LGPv 1420

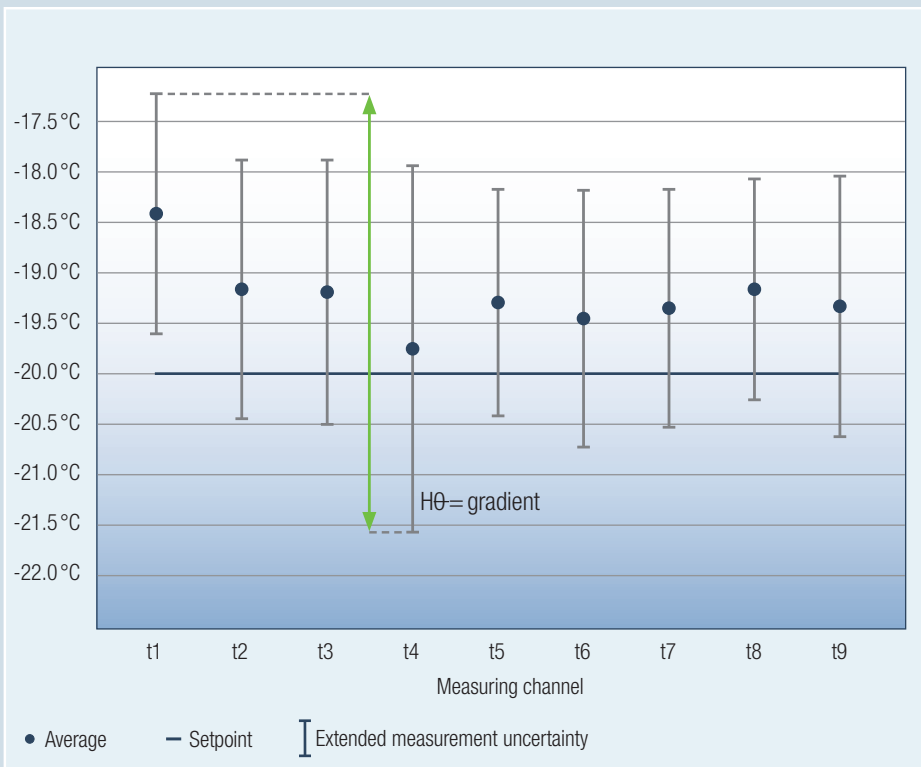

Gradient H0- : **4.3K**

Max. fluctuation: **6.7K**

Test results according to EN 60068-3 for laboratory appliances LK(U)v, LC(ex)v, LK(U)exv, LG(U)ex and LGT

The evaluation of the air temperatures in the interior according to the test procedure EN 60068-3 measured with PT 100 measuring elements has the following results for the LK(U)v, LC(ex)v, LK(U)exv, LG(U)ex and LGT laboratory fridges and freezers:

LKUv 1610

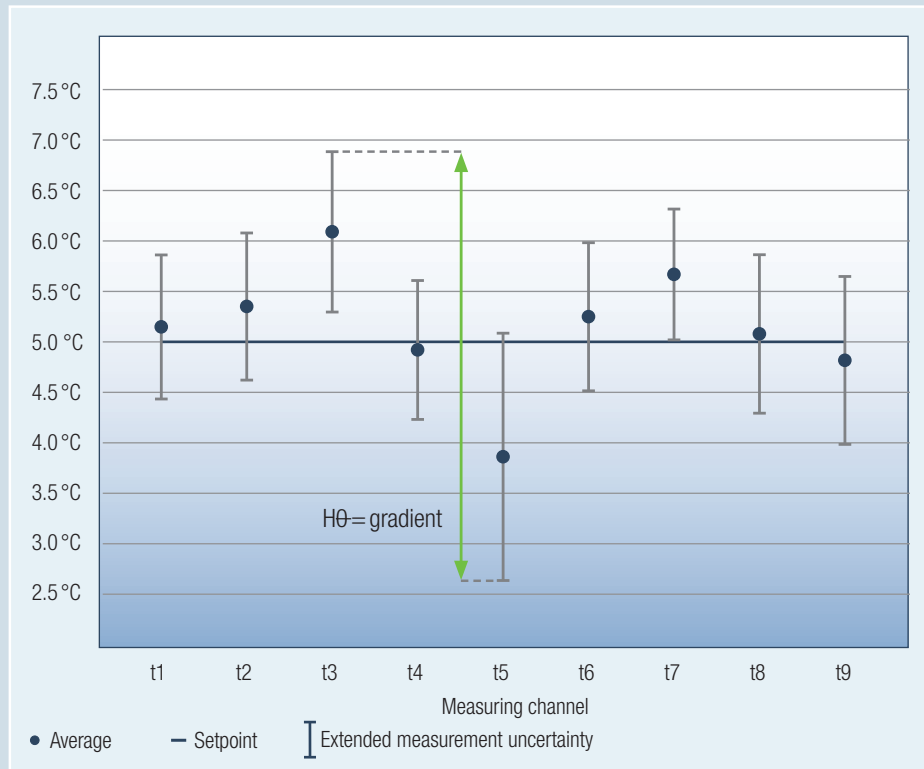

Gradient H0- : **4.3K**

Max. fluctuation: **4.6K**

LKUv 1613

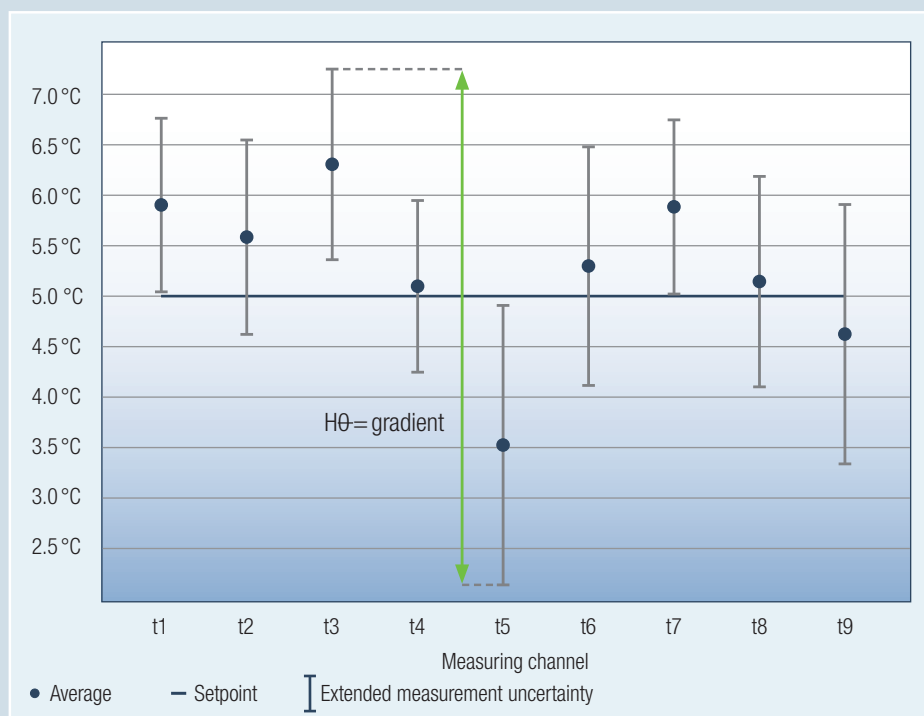

Gradient H0- : **5.1K**

Max. fluctuation: **4.9K**

LKUexv 1610

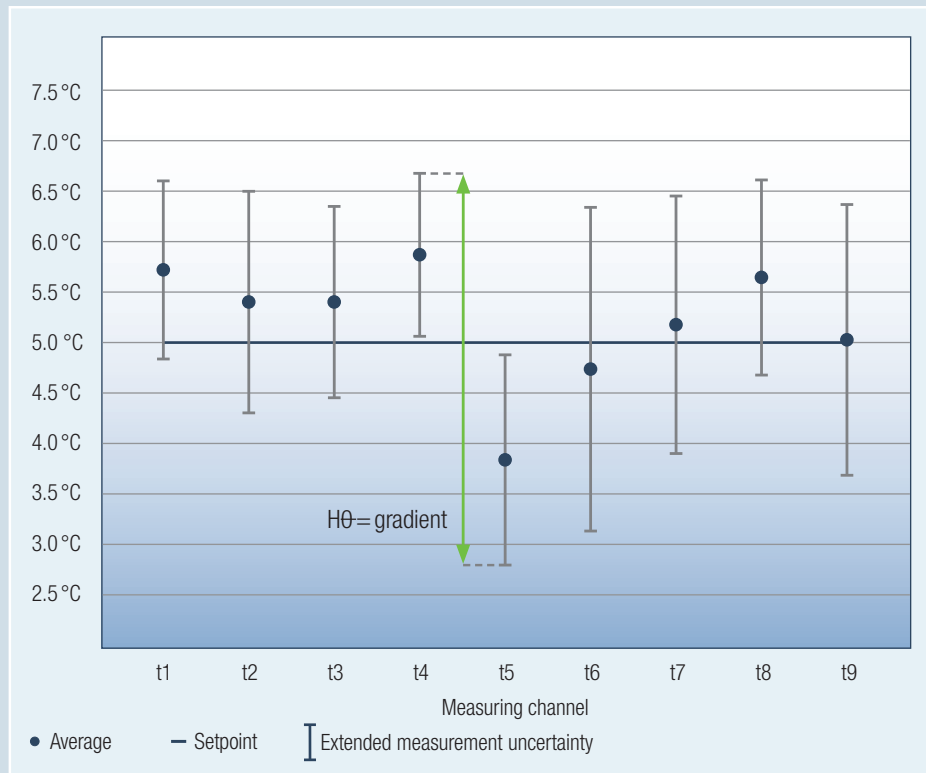

Gradient H0- : **3.9K**

Max. fluctuation: **4.8K**

LGUex 1500

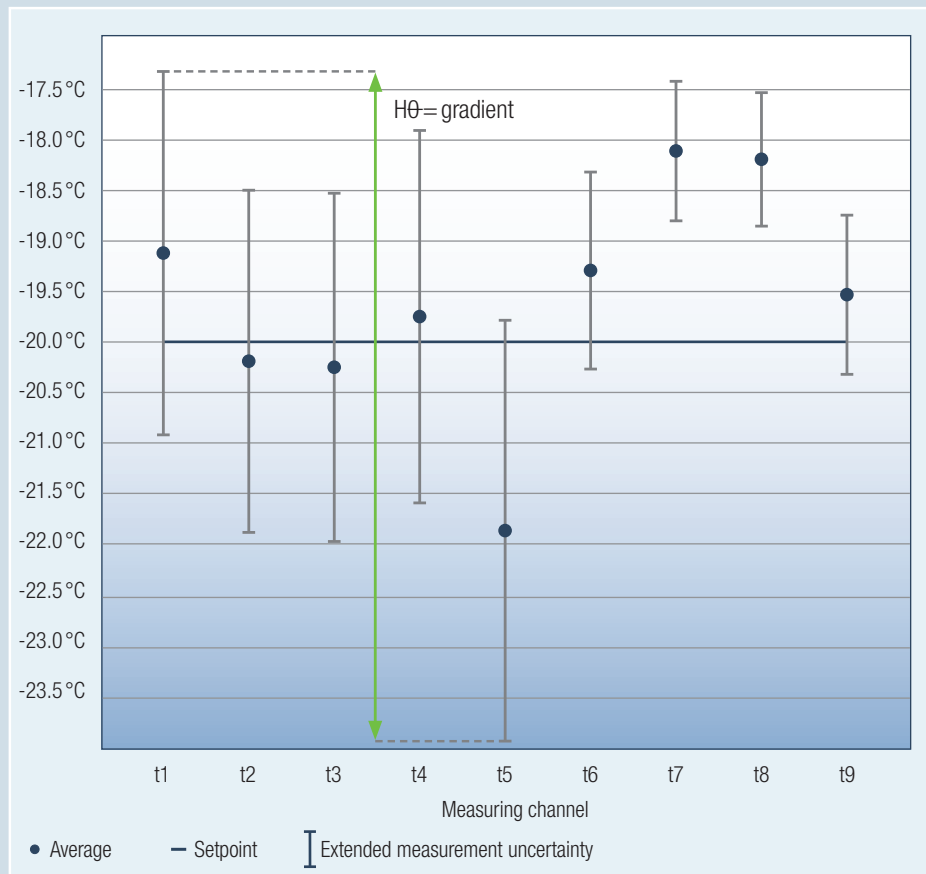

Gradient H0- : **6.6K**

Max. fluctuation: **3.3K**

LKv 3910

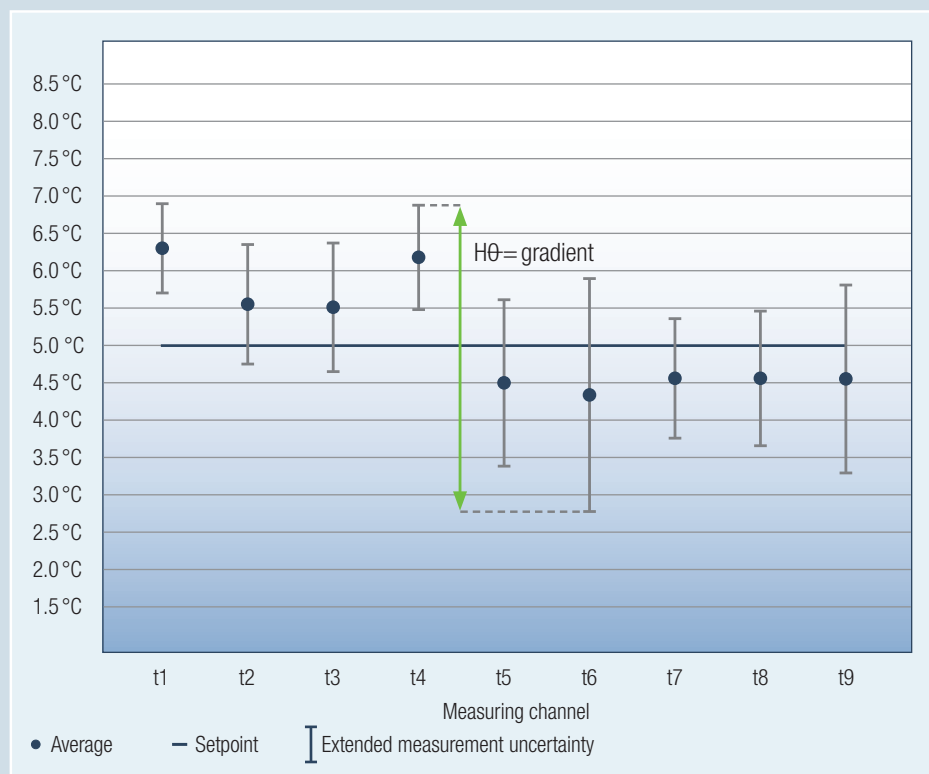

Gradient H0- : **4.1 K**

Max. fluctuation: **3.6 K**

LKv 3913

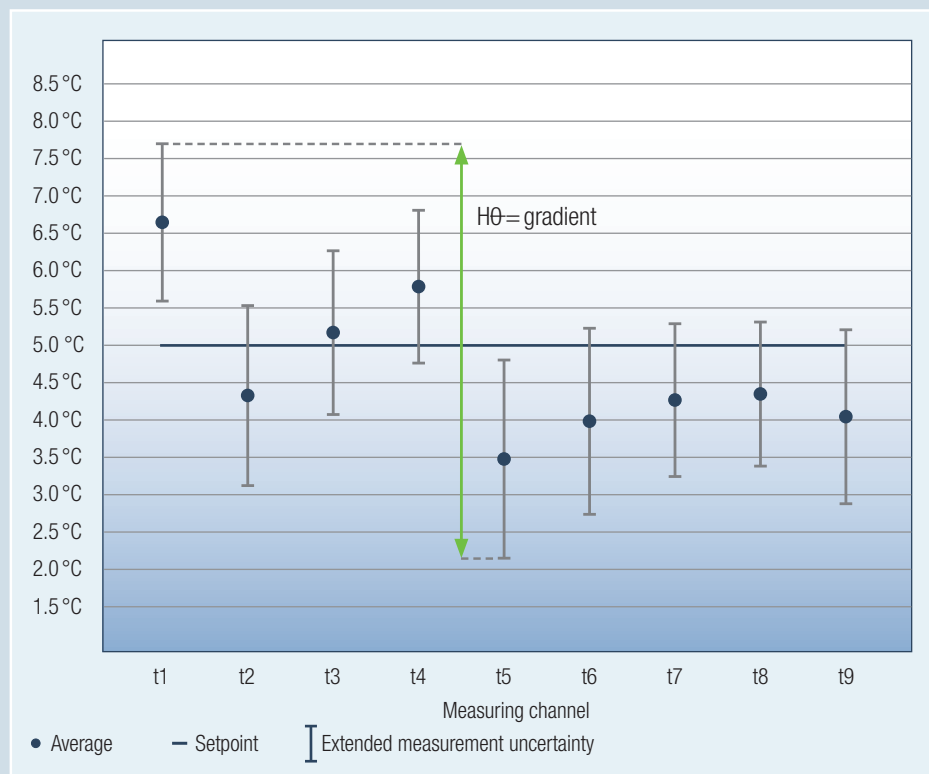

Gradient H0- : **5.6 K**

Max. fluctuation: **4.7 K**

LKv 5710

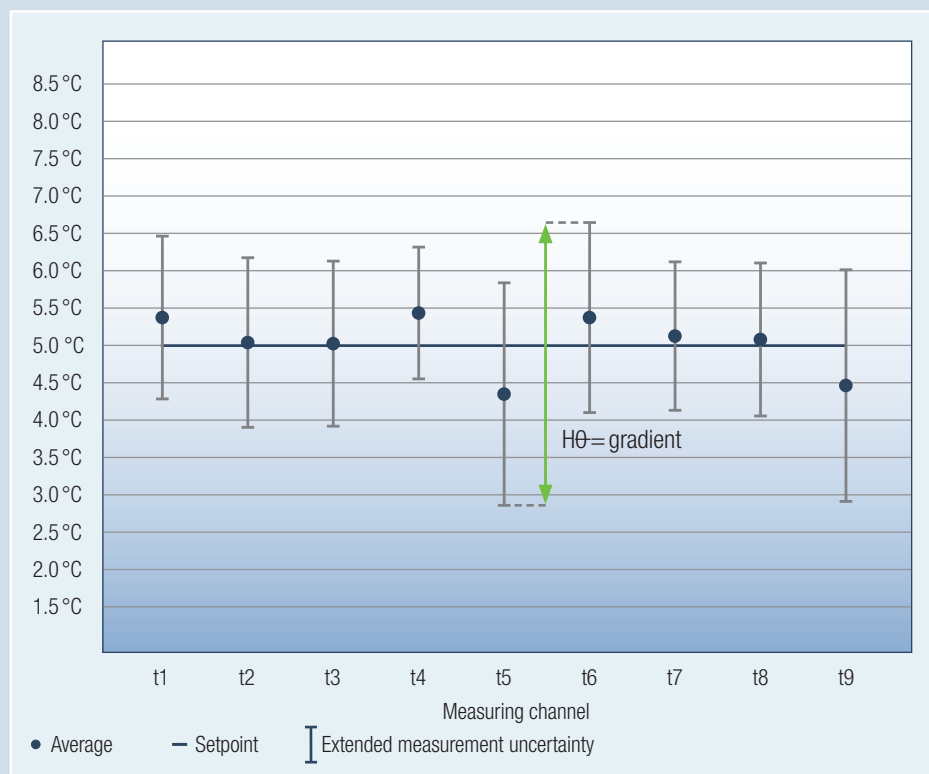

Gradient $H\theta$ - : **3.8K**

Max. fluctuation: **3.1K**

LKexv 3910

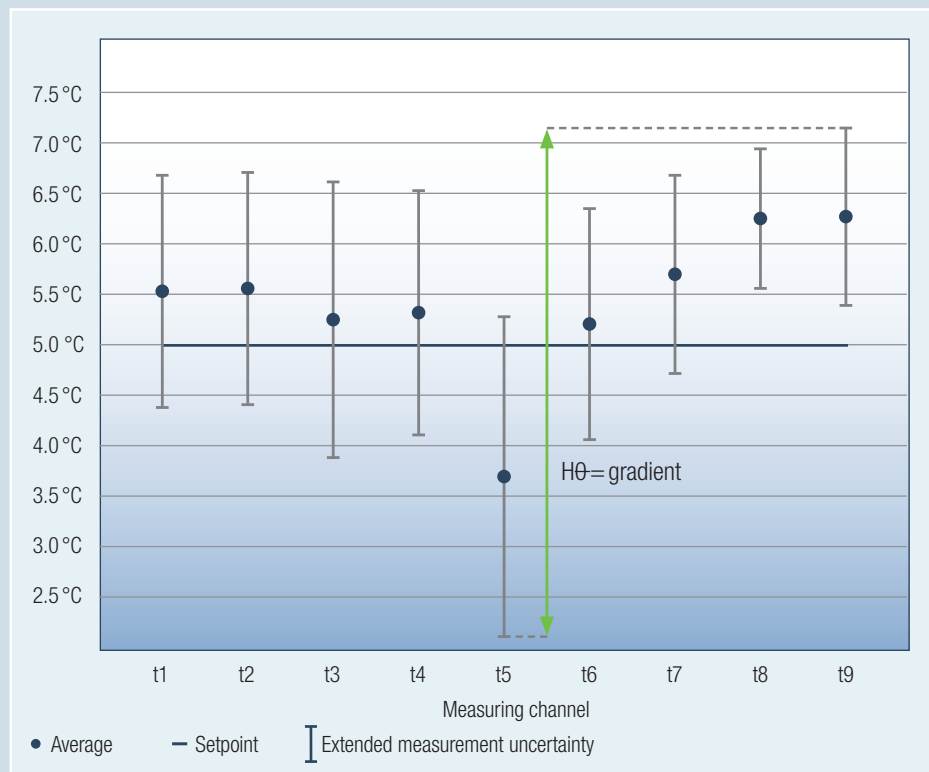

Gradient $H\theta$ - : **5.5K**

Max. fluctuation: **5.1K**

LGex 3410

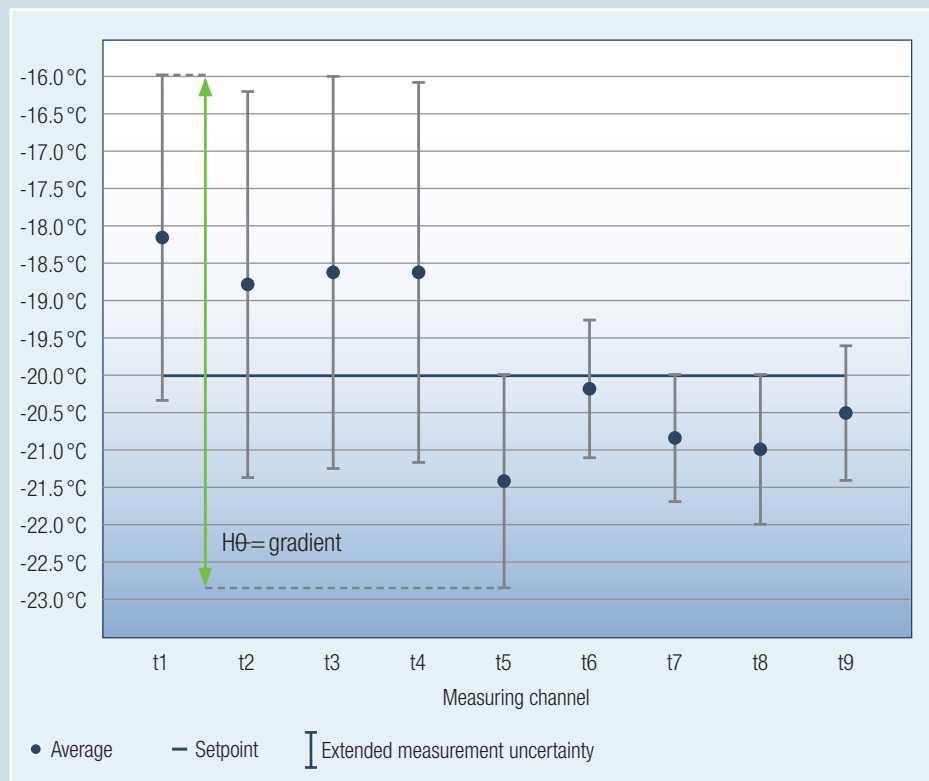

Gradient H θ - : **6.9K**

Max. fluctuation: **4.2K**

LGv 5010

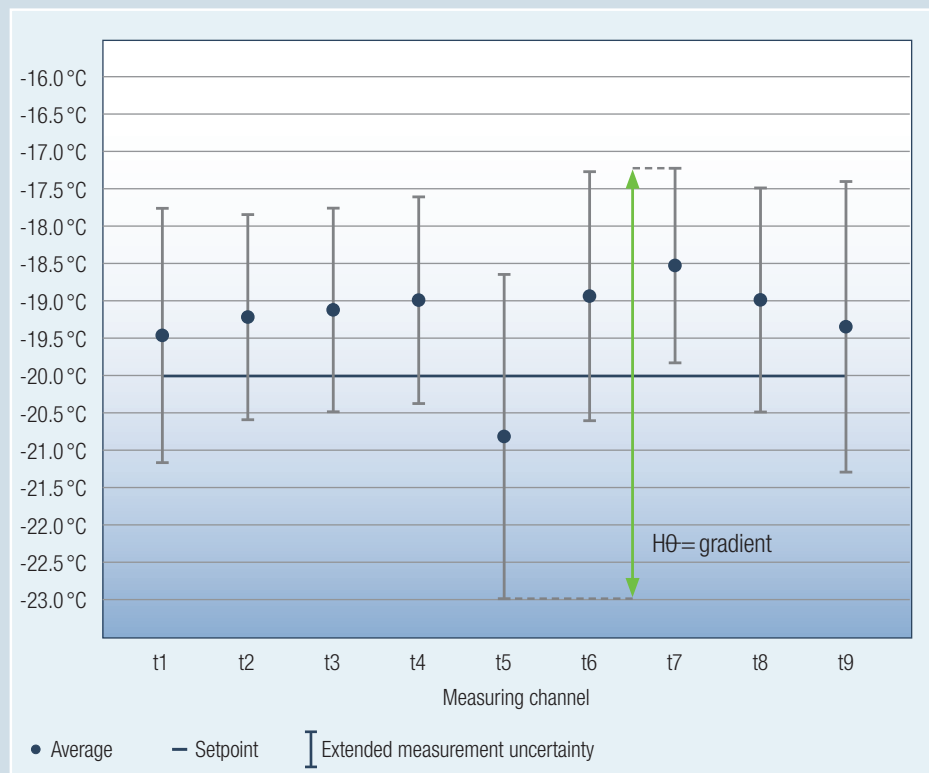

Gradient H θ - : **5.8K**

Max. fluctuation: **4.9K**

LCv 4010 – evaluation of fridge compartment

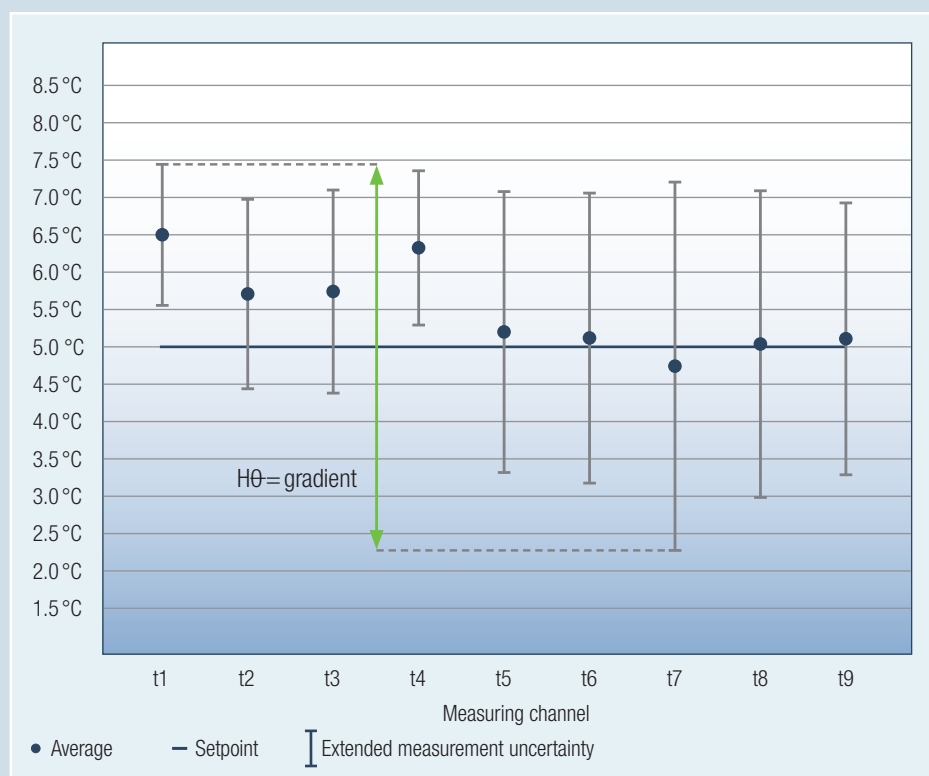

Gradient H0- : **5.2K**

Max. fluctuation: **5.7K**

LCv 4010 – evaluation of freezer compartment

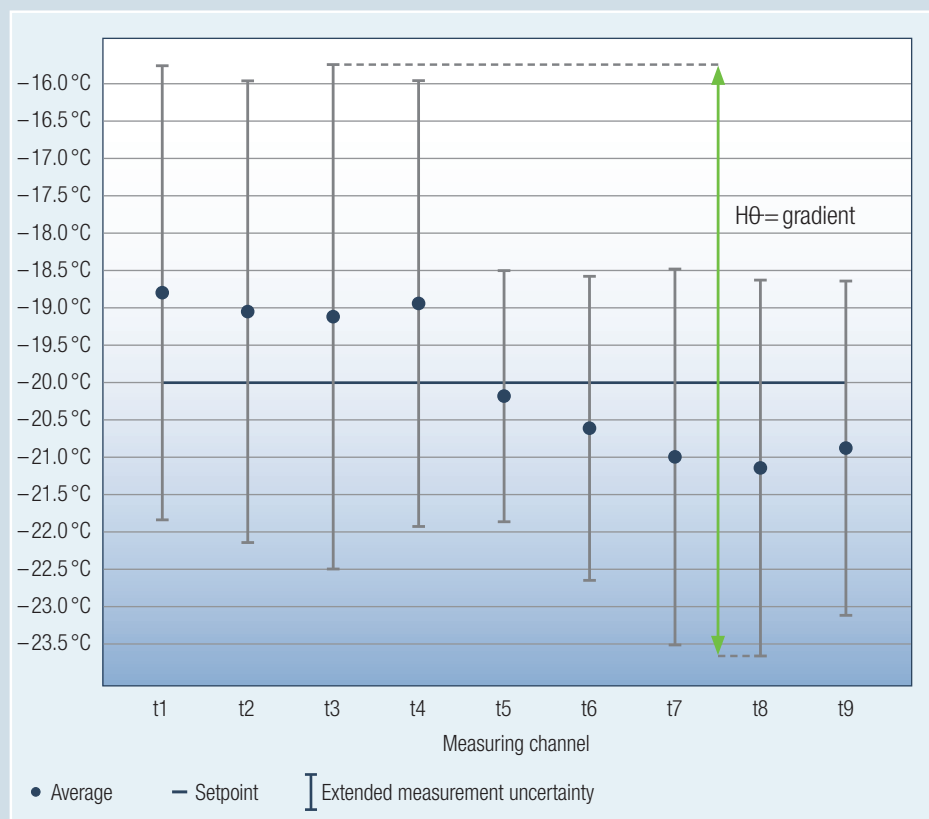

Gradient H0- : **7.9K**

Max. fluctuation: **5.5K**

LCexv 4010 – evaluation of fridge compartment

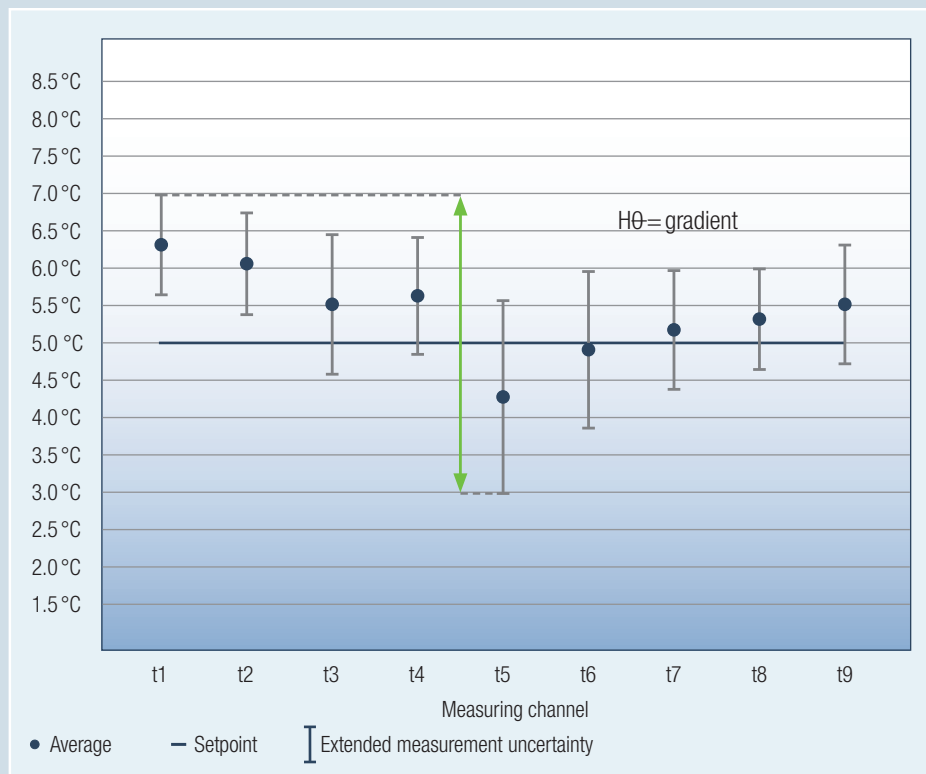

Gradient H0- : **4.0K**

Max. fluctuation: **3.9K**

LCexv 4010 - evaluation of freezer compartment

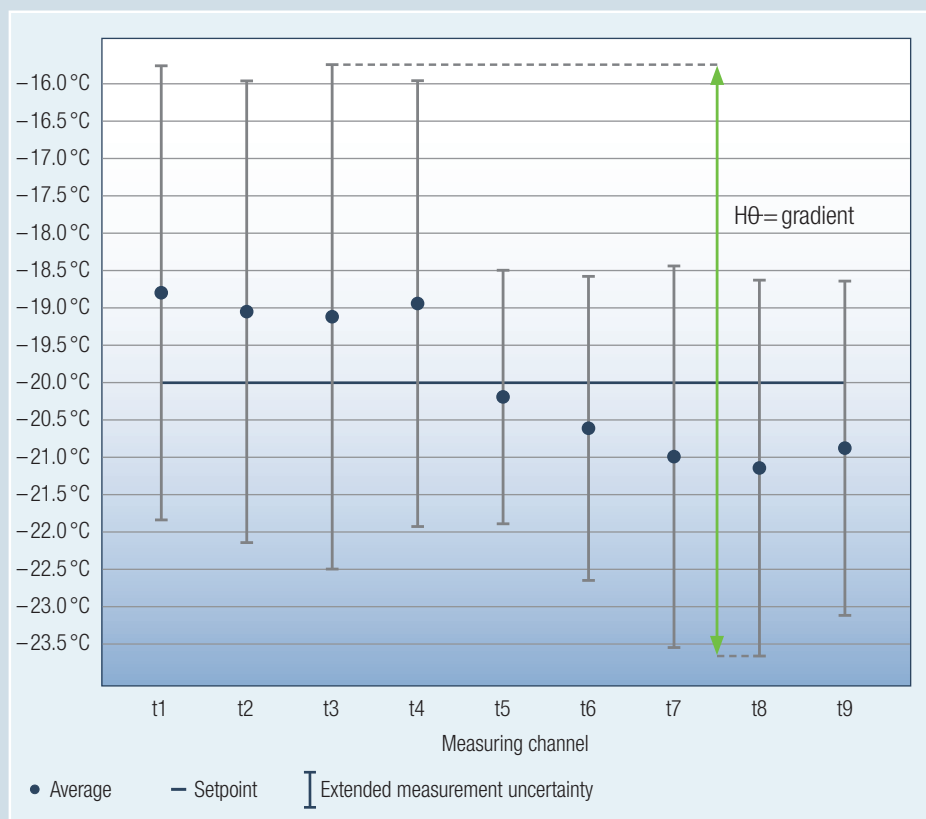

Gradient H0- : **7.9K**

Max. fluctuation: **5.5K**

LGT 2325 *

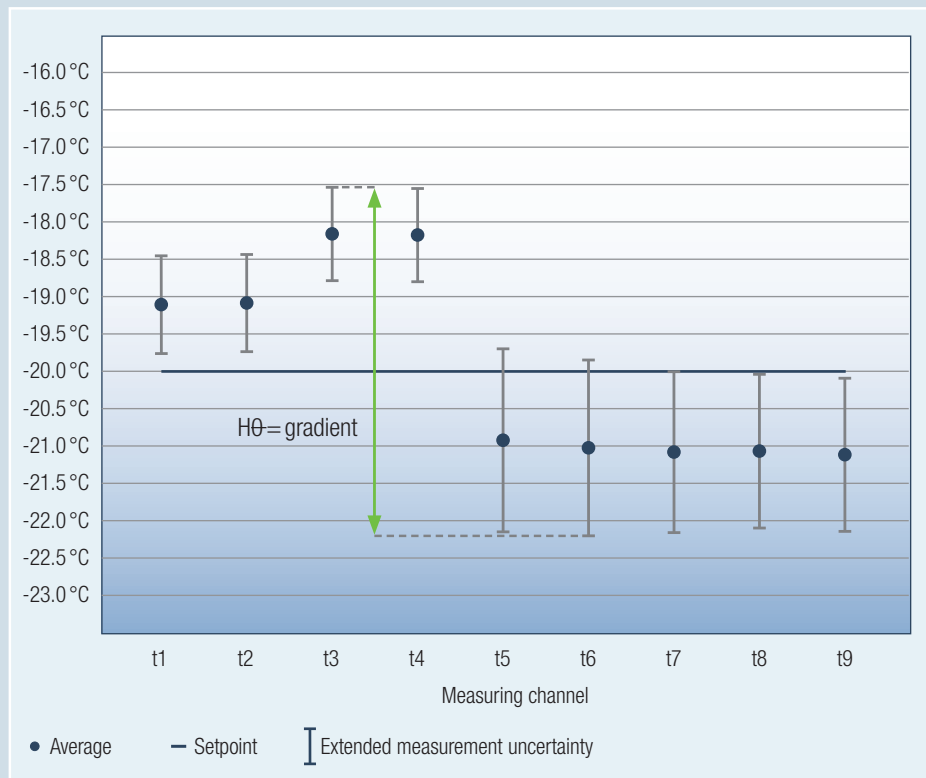

Gradient H0-: **4.7K**

Max. fluctuation: **1.9K**

* At an operating temperature of -20°C it is recommended to change the preset offset from 2.7 K to 1.0 K (see operating instructions).

LGT 3725 *

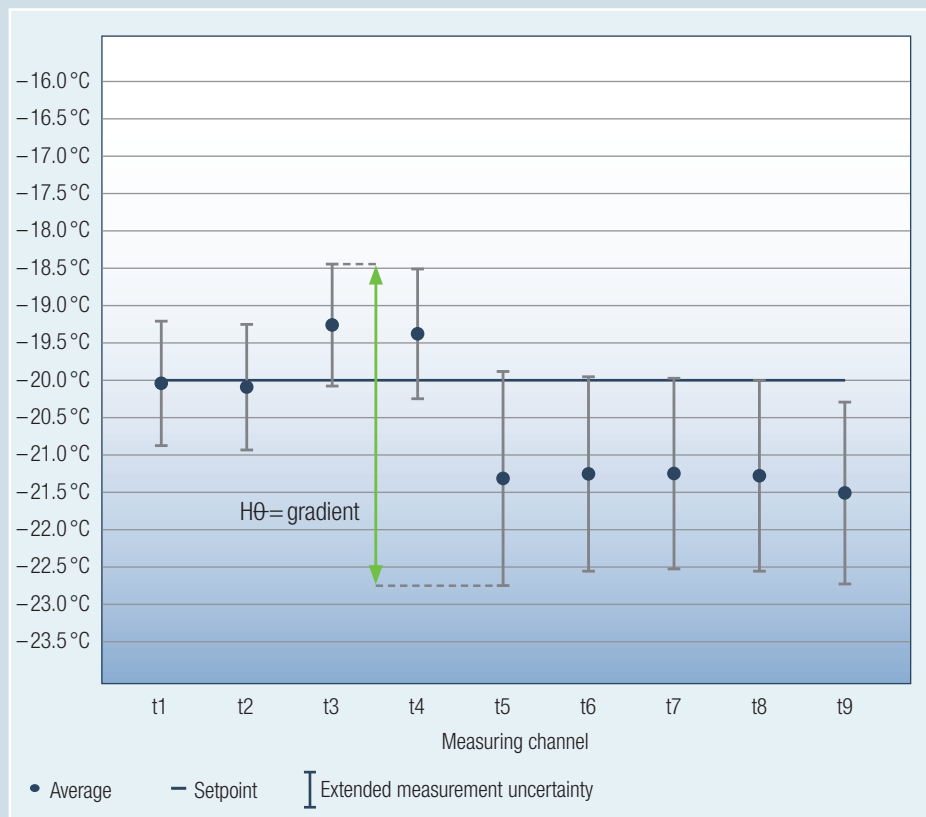

Gradient H0- : **4.3K**

Max. fluctuation: **2.2K**

* At an operating temperature of -20°C it is recommended to change the preset offset from 2.7 K to 1.0 K (see operating instructions).

LGT 4725 *

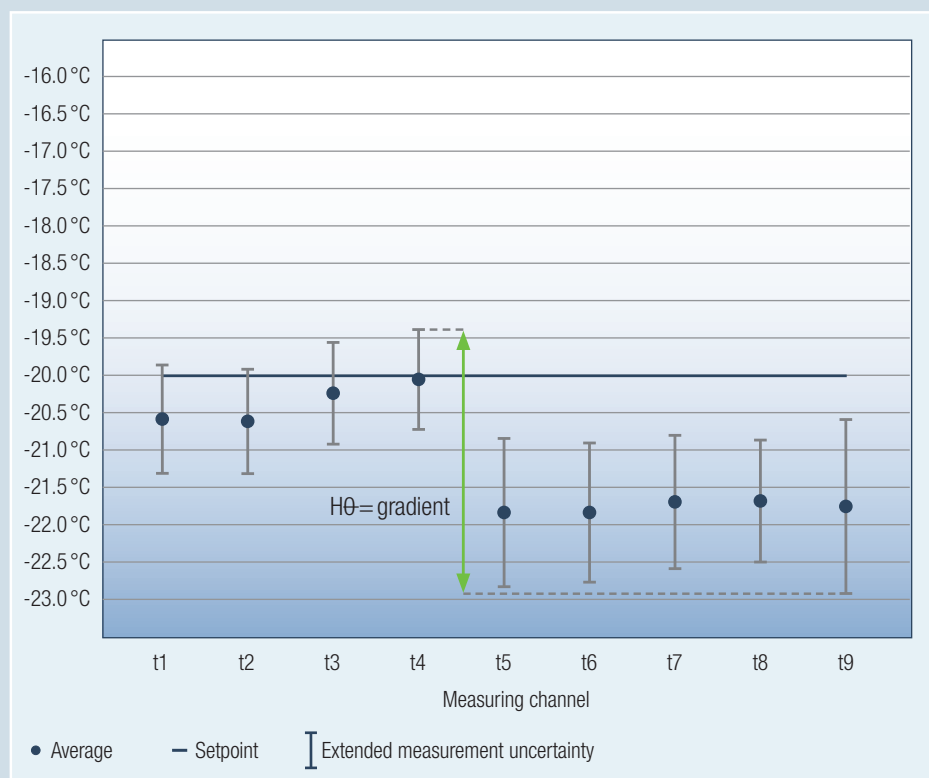

Gradient H0-: **3.5K**

Max. fluctuation: **1.8K**

* At an operating temperature of -20°C it is recommended to change the preset offset from 2.7 K to 1.0 K (see operating instructions).

Test results according to EN 60068-3 for pharmacy fridges compliant with DIN 58345

The evaluation of the air temperatures in the interior according to the test procedure EN 60068-3 measured with PT 100 measuring elements gives the following results. Please note that these are reference values only:

MKv 3910

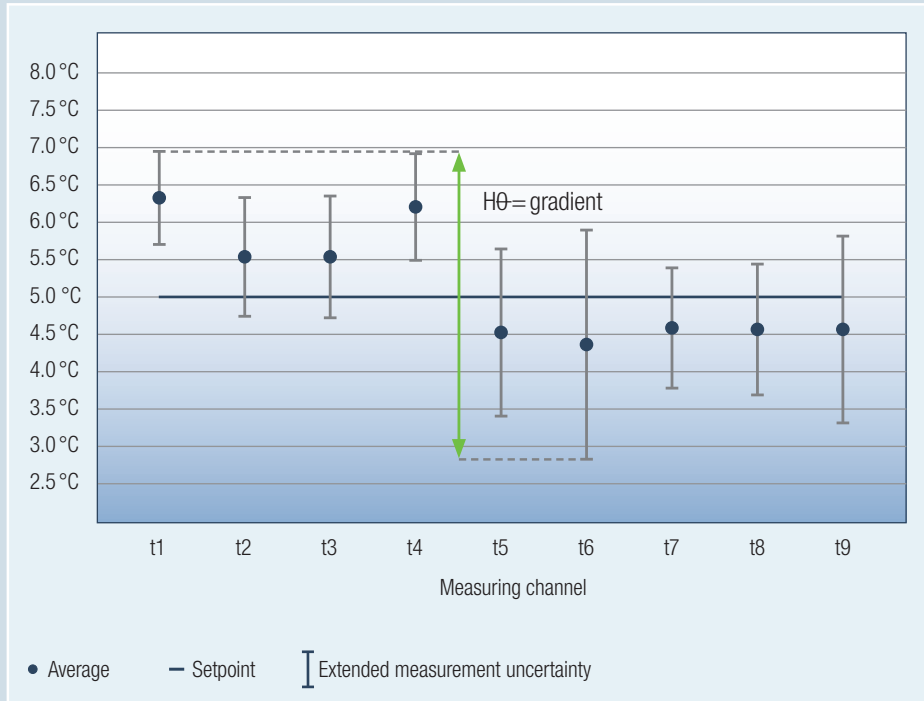

Gradient H θ : **4.1 K**

Max. fluctuation: **3.6 K**

MKv 3913

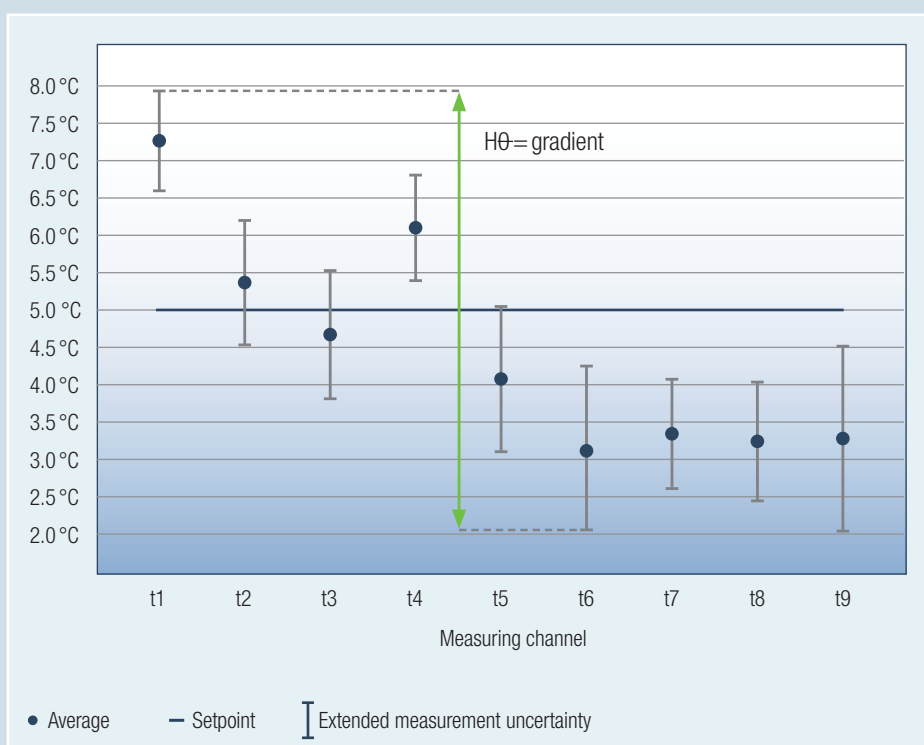

Gradient H θ : **6.0 K**

Max. fluctuation: **3.9 K**

MKUv 1610

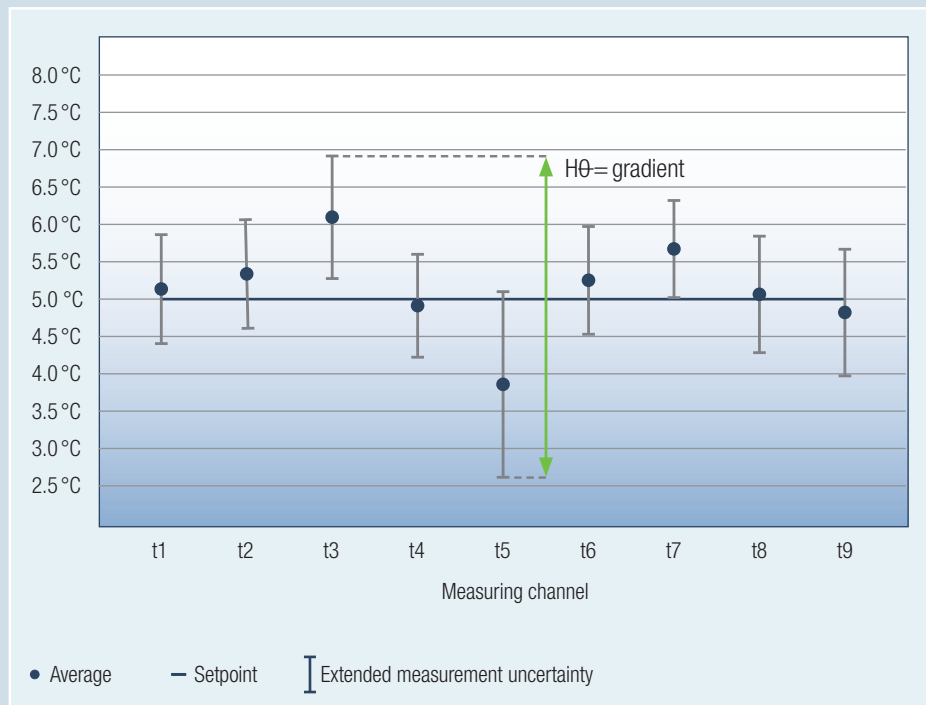

Gradient H0- : **4.3K**

Max. fluctuation: **4.6K**

MKUv 1613

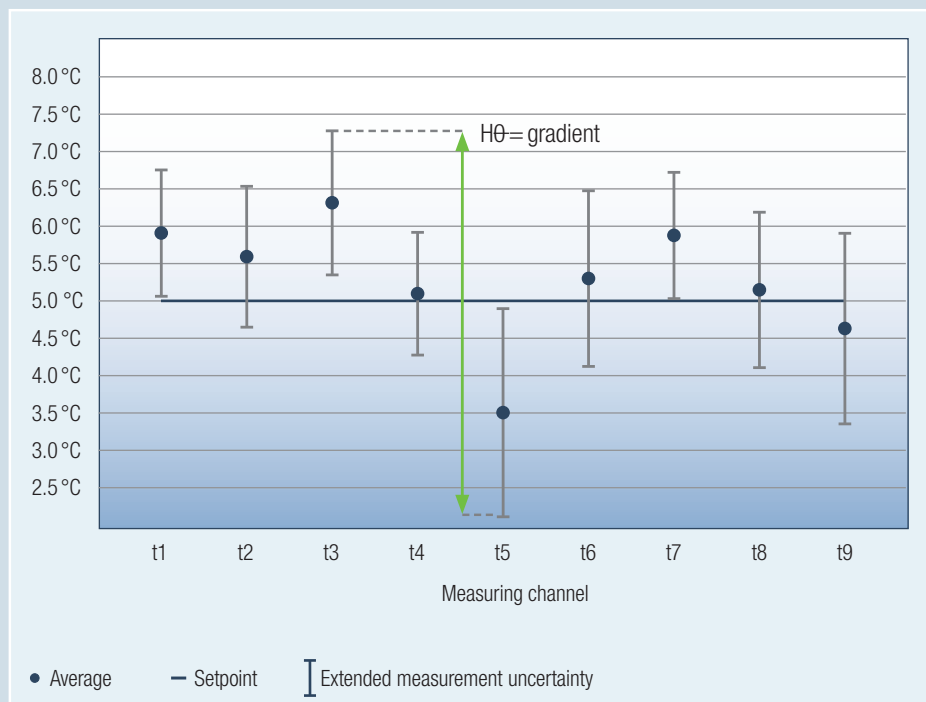

Gradient H0- : **5.1K**

Max. fluctuation: **4.9K**

MKv 3910 variant H63

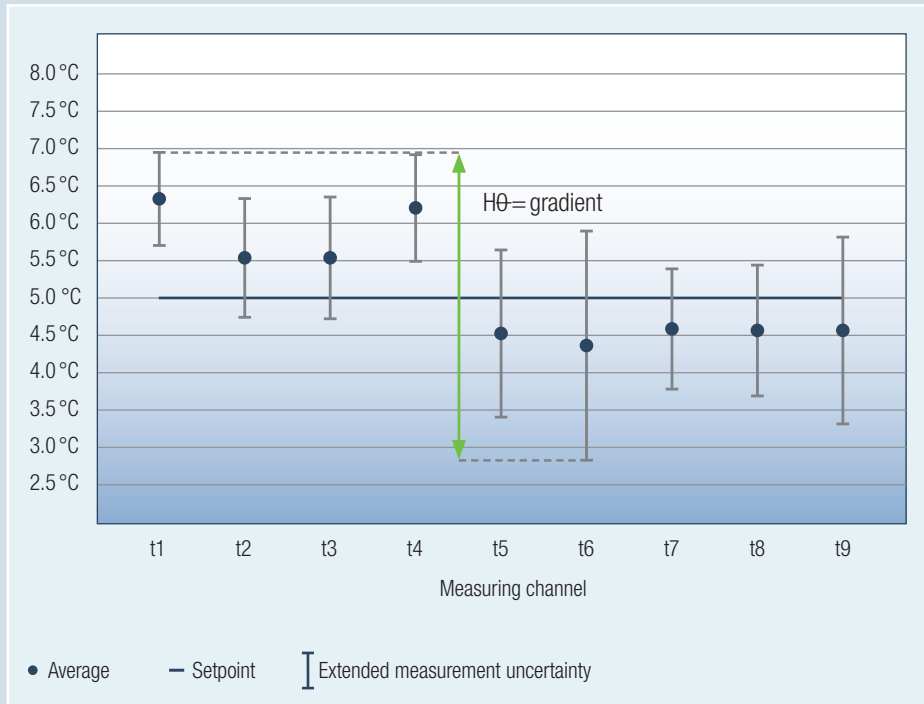

Gradient H0- : **4.1K**

Max. fluctuation: **3.6K**

MKv 3913 variant H63

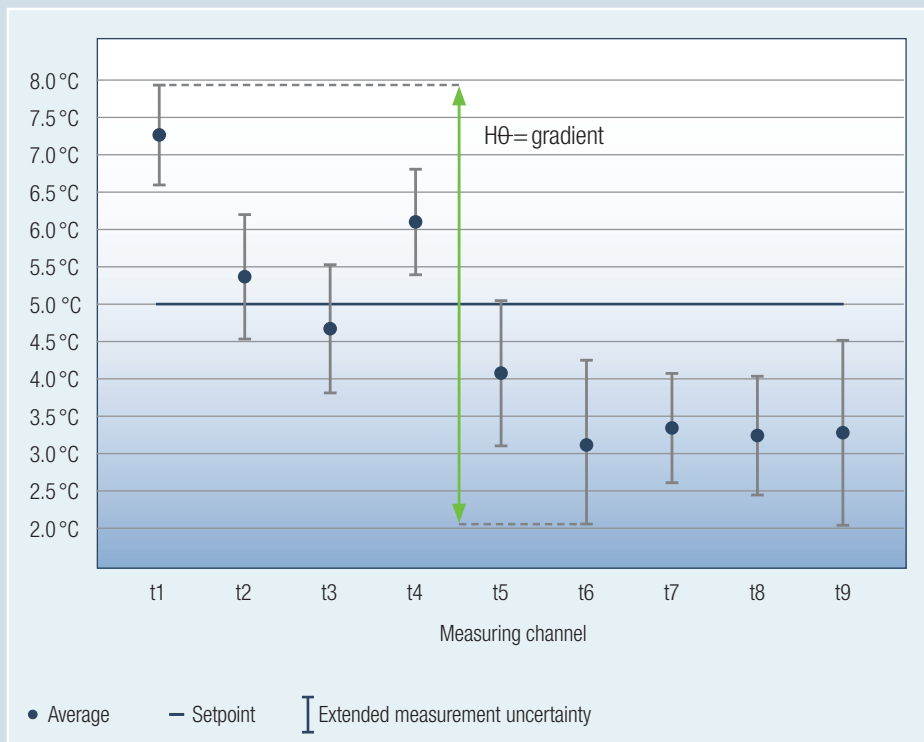

Gradient H0- : **6.0K**

Max. fluctuation: **3.9K**

MKUv 1610 variant H63

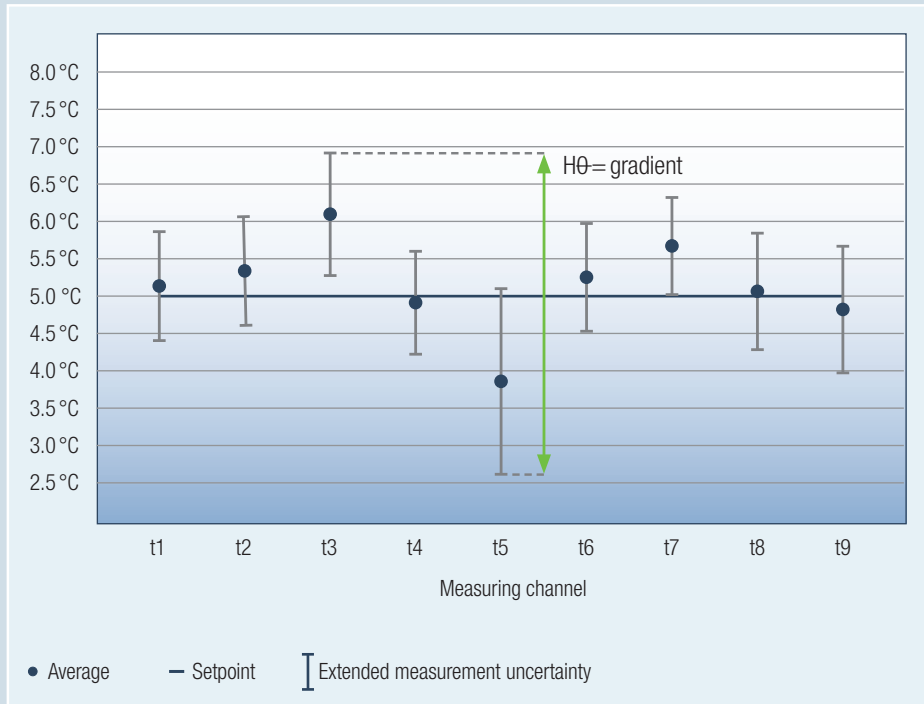

Gradient H0- : **4.3K**

Max. fluctuation: **4.6K**

MKUv 1613 variant H63

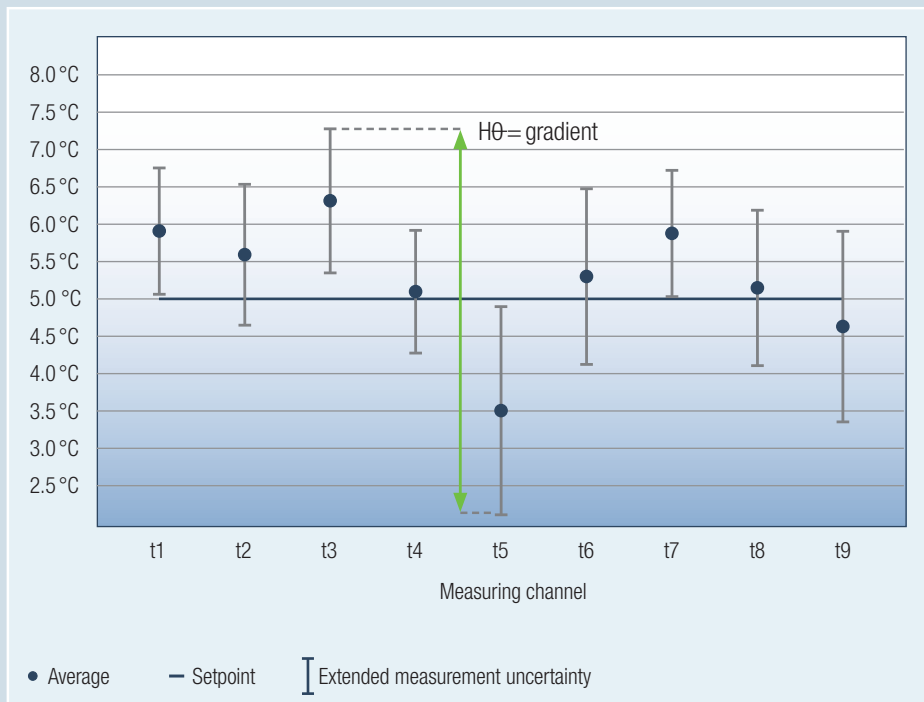

Gradient H0- : **5.1K**

Max. fluctuation: **4.9K**

Test results according to EN 60068-3 for laboratory appliances LKexv

The evaluation of the air temperatures in the interior according to the test procedure EN 60068-3 measured with PT 100 measuring elements gives the following results. Please note that these are reference values only:

LKexv 5400

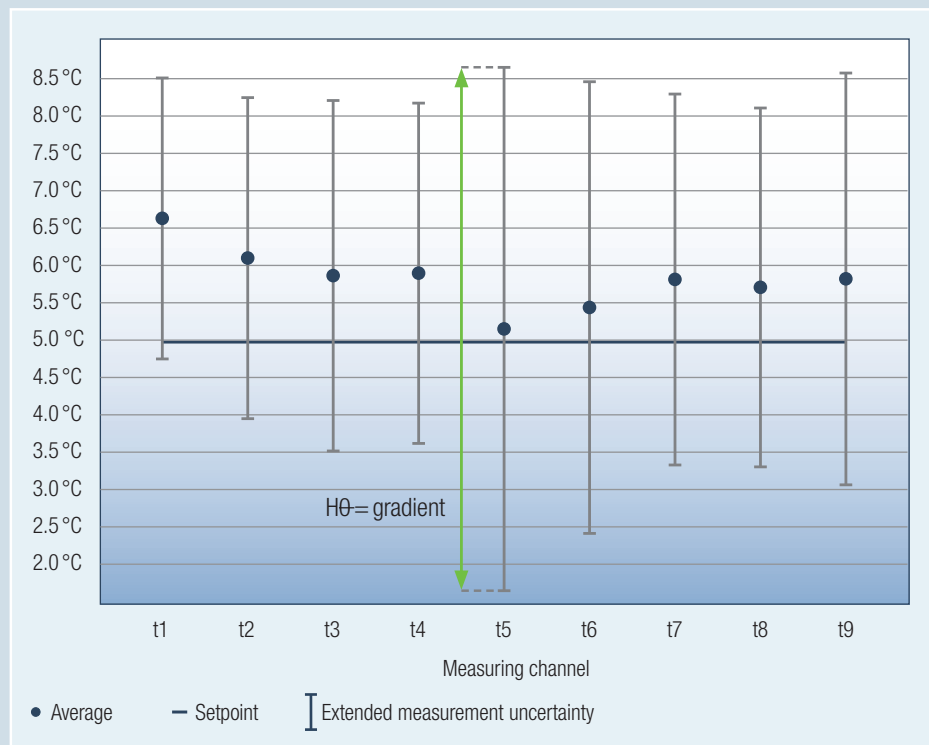

Gradient H0- : **6.9K**

Max. fluctuation: **5.8K**

LKexv 3600

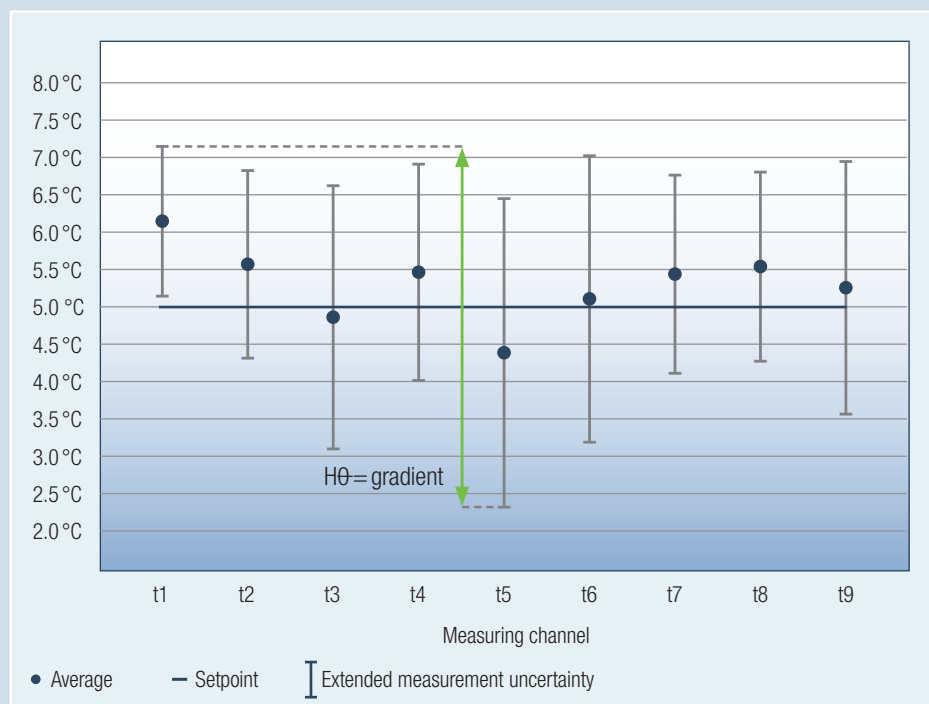

Gradient H0- : **4.8K**

Max. fluctuation: **3.0K**

LKexv 2600

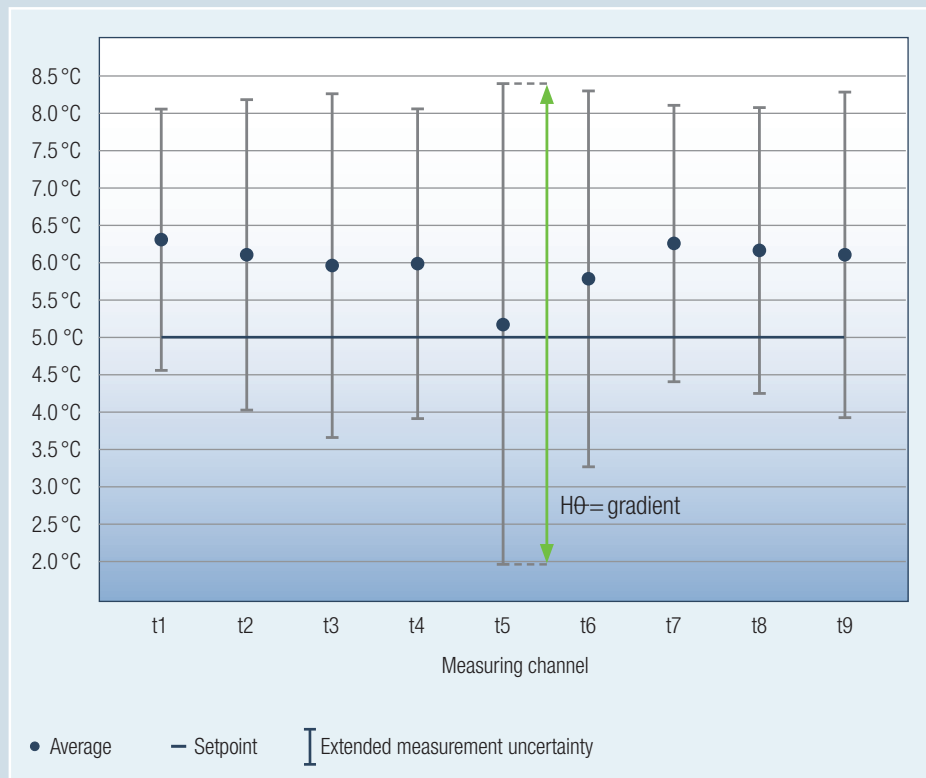

Gradient Hθ : **6.4K**

Max. fluctuation: **5.5K**

LKexv 1800

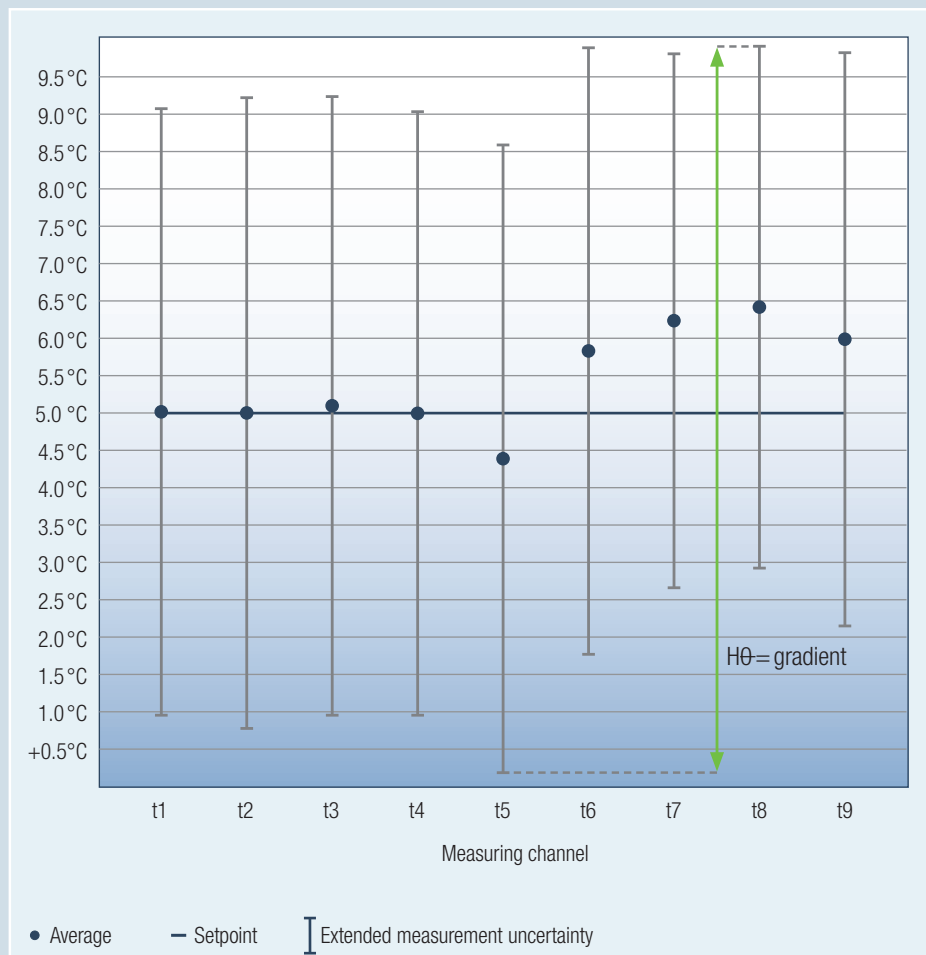

Gradient Hθ : **10.2K**

Max. fluctuation: **7.4K**

Maximum Rack-Loading SUFsg 5001/7001

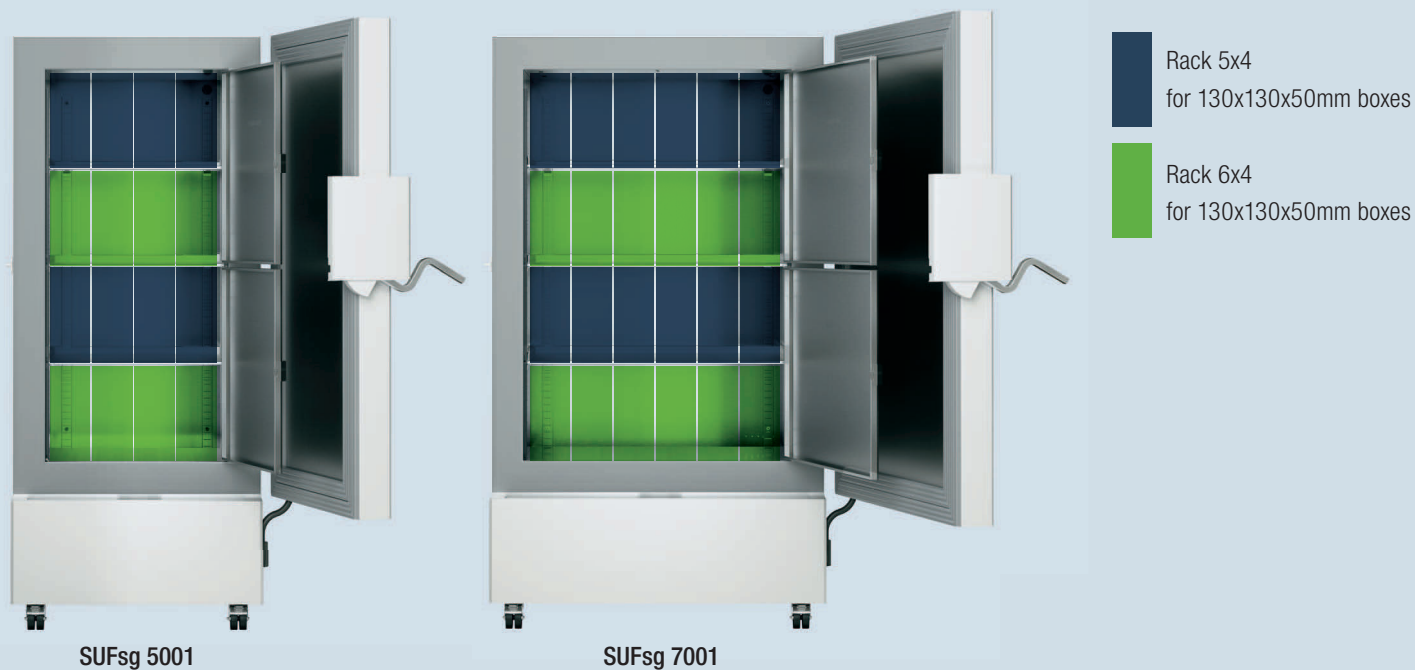

Maximum Loading SUFsg 5001:

8x Rack 5x4 + 8x Rack 6x4 = 352 boxes x 81 pcs. 2mL samples = 28.512 samples

Maximum Loading SUFsg 7001:

12x Rack 5x4 + 12x Rack 6x4 = 528 boxes x 81 pcs. 2mL samples = 42.768 samples

Shelf-position for maximum loading explained in manual



Aluminium-Rack 5x4 with drawers



Kryo-Box 130x130x50mm for 81 pcs. 2ml probes

Aluminium side-access rack 5 x 4	7790003	Stainless steel side-access rack 5 x 4	7790027
Aluminium side-access rack 6 x 4	7790014	Stainless steel side-access rack 6 x 4	7790028
Aluminium side-access rack 5 x 4 + cryoboxes	7790015	Stainless steel front-access rack 5 x 4 + drawers	7790031
Aluminium side-access rack 6 x 4 + cryoboxes	7790025	Stainless steel front-access rack 6 x 4 + drawers	7790032
Stainless steel side-access rack 5 x 4 + cryoboxes	7790029	Stainless steel front-access rack 5 x 4 + cryoboxes + drawers	7790033
Stainless steel side-access rack 6 x 4 + cryoboxes	7790030	Stainless steel front-access rack 6 x 4 + cryoboxes + drawers	7790036

Loading sketches: Laboratory chest freezers with cryo racks

(for boxes 50 mm in height)

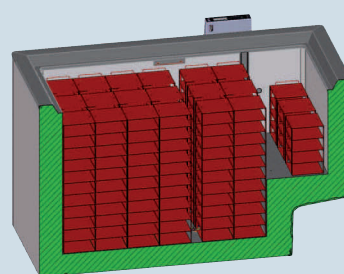
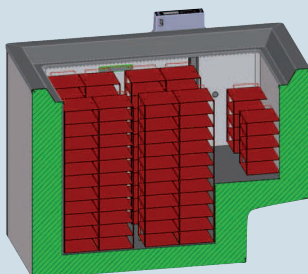

	LGT 2325	LGT 3725
Interior dimensions (W/D/H) in mm	889/410/630	1170/500/630
Number of racks: 140/140/604 mm	8	18
Number of racks: 140/140/222 mm	2	3
Number of boxes: 130/130/50 mm	96	210
Maximum height of the racks:	630 mm	630 mm
Maximum height of the racks above the compressor:	375 mm	360 mm

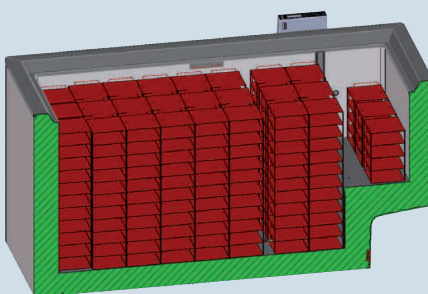

	LGT 4725
Interior dimensions (W/D/H) in mm	1445/500/630
Number of racks: 140/140/604 mm	24
Number of racks: 140/140/222 mm	3
Number of boxes: 130/130/50 mm	276
Maximum height of the racks:	630 mm
Maximum height of the racks above the compressor:	360 mm

Visit eu.fishersci.com for more information

Distributed by Fisher Scientific. Contact us today:

Austria: fishersci.at **Belgium:** fishersci.be **Denmark:** fishersci.dk
Germany: fishersci.de **Ireland:** fishersci.ie **Italy:** fishersci.it
Finland: fishersci.fi **France:** fishersci.fr **Netherlands:** fishersci.nl
Norway: fishersci.no **Portugal:** fishersci.pt **Spain:** fishersci.es
Sweden: fishersci.se **Switzerland:** fishersci.ch **UK:** fishersci.co.uk

© 2024 Thermo Fisher Scientific Inc. All rights reserved.
Trademarks used are owned as indicated at fishersci.com/trademarks.

21592

